



Installation Guide

System Overview, Components, Tools & Accessories,
Construction Process, Installation Procedures,
Bracing, Core Filling

Legal statements

Important legal statements

Reasonable efforts have been made to ensure the accuracy of this publication; however, any information or data contained herein is subject to change without notice. To ensure the information you are using is correct, AFS recommends you review the latest technical information available on the AFS website www.afsformwork.com.au, or alternatively call 1300 727 237 to speak to a Technical Representative.

The AFS logo and rediwall® mark are registered trade marks. © 2019 AFS SYSTEMS PTY LTD. No part of this publication may be reproduced in any form or by any means without prior written permission from AFS Systems Pty Ltd. All rights reserved.



Disclaimer

This AFS Rediwall® Installation Guide is intended to represent good building practice in achieving structural design of rediwall®. This section is not intended in any way by AFS to represent all relevant information required on a project. It is the responsibility of those using and designing rediwall®, including but not limited to builders, designers, consultants and engineers to ensure that the use of rediwall® complies with all the relevant National Construction Code (NCC) requirements such as, but not limited to structural adequacy, acoustic, fire resistance/ combustibility, thermal, and weatherproofing provisions. All diagrams, plans and illustrations used in this section, including any reinforcement shown, are supplied for indicative and diagrammatic purposes only. It remains the responsibility of those using rediwall® to ensure that reference is made to the project engineer's structural details for all construction and reinforcement requirements.

TABLE OF CONTENTS

Legal statements	2
Disclaimer.....	2
INTRODUCTION	4
SYSTEM OVERVIEW	5
Rediwall® Product Description.....	8
Rediwall® System Benefits	8
COMPONENTS, TOOLS & ACCESSORIES	9
Components for RW110C System.....	9
Components for RW156C System.....	11
Components for RW200C System.....	14
Components for RW256S System.....	17
Tools & Accessories	18
THE CONSTRUCTION PROCESS	22
Construction Process Overview	22
Ordering	25
How to order	25
CONSTRUCTION AND INSTALLATION PROCEDURES	26
Introduction	26
Component Delivery & Worksite Layout	27
Floor/Wall Junction – Floor Track Installation	28
Control Joints	30
Starting Location	30
Corner Construction	31
Wall Construction	32
Wall Reinforcement.....	33
Corner Reinforcement	35
Corner Reinforcement - alternate method.....	36
Wall Construction	37
Safety Rail/Balustrade Wall Installation.....	38
Steel Reinforcement Installation	39
T Junction Construction.....	40
Obtuse Corner Construction.....	41
H Joiner Installation	43
H-Joiner Installation (Limited Site Access).....	44
Accessory Extensions.....	45
End Cap Installation.....	46
RW256S Blade Wall	47
Rediwall® Edge Form	48
Rediwall® J-Track Installation	49
Window Openings	50
Doorway & Lintel Installation	52
Wide Radius Curved Wall Installation	55
Curved Wall Reinforcement Bar Installation	56
Stairway Landing Construction	57
Retention Tank Construction & Tanking.....	58
Lift Pit.....	59
Installation of Services	60
Penetrations	61
REDIWALL® TEMPORARY CONSTRUCTION BRACING	63
Bracing of Walls.....	64
CORE FILLING OF WALLS	72

INTRODUCTION

This Installation Guide forms part of a comprehensive AFS Rediwall Design Guide (Vol1, Vol2 & Vol 3) which includes chapters dedicated to Design, Performance, Compliance, Construction, Finishes and Installation of Rediwall. This Guide should be read in conjunction with Vol 1 & Vol 2. Downloads of these chapters are available via the Resource Centre at www.afsformwork.com.au.

Our innovative afs logicwall® fibre cement, and afs rediwall® pvc permanent formwork walling systems have enabled the speedy and cost-efficient installation of load-bearing walls across a range of projects including multi-residential, hotels, aged care facilities, shopping centres and student accommodation.

No matter what the application from the basement right through to the penthouse, we have a comprehensive walling solution to meet the demands of any project as only AFS is able to offer you the versatility of both a fibre cement or pvc walling solution.

Our rediwall® pvc system's extruded components simply snap or slide together to create a concrete formwork erected with maximum efficiency. Rediwall® requires almost no machinery-aided installation. In fact, installations can be undertaken without the need for any detailed training. And with its high quality semi-gloss finish it requires no additional finishing for most applications.

Suitable as a tough load bearing solution for building subterranean structures such as basements and retention tanks, it can also be utilized for above ground applications such as party walls, columns and retaining walls, making it a truly versatile solution.



Backed by one of Australia's most trusted brands

AFS Systems is a division of CSR Building Products Limited, one of Australia's leading building products companies.

We form part of CSR's portfolio of trusted brands - amongst some of the biggest names in the Australasian building products industry.



**smarter
permanent
formwork.™**

SYSTEM OVERVIEW

AFS Rediwall® systems provide loadbearing wall solutions for residential or commercial structures and multi storey buildings. These systems can be used for both above and below ground structures. The rediwall®

systems are highly modular, providing architects and engineers the freedom to design buildings to suit various applications.

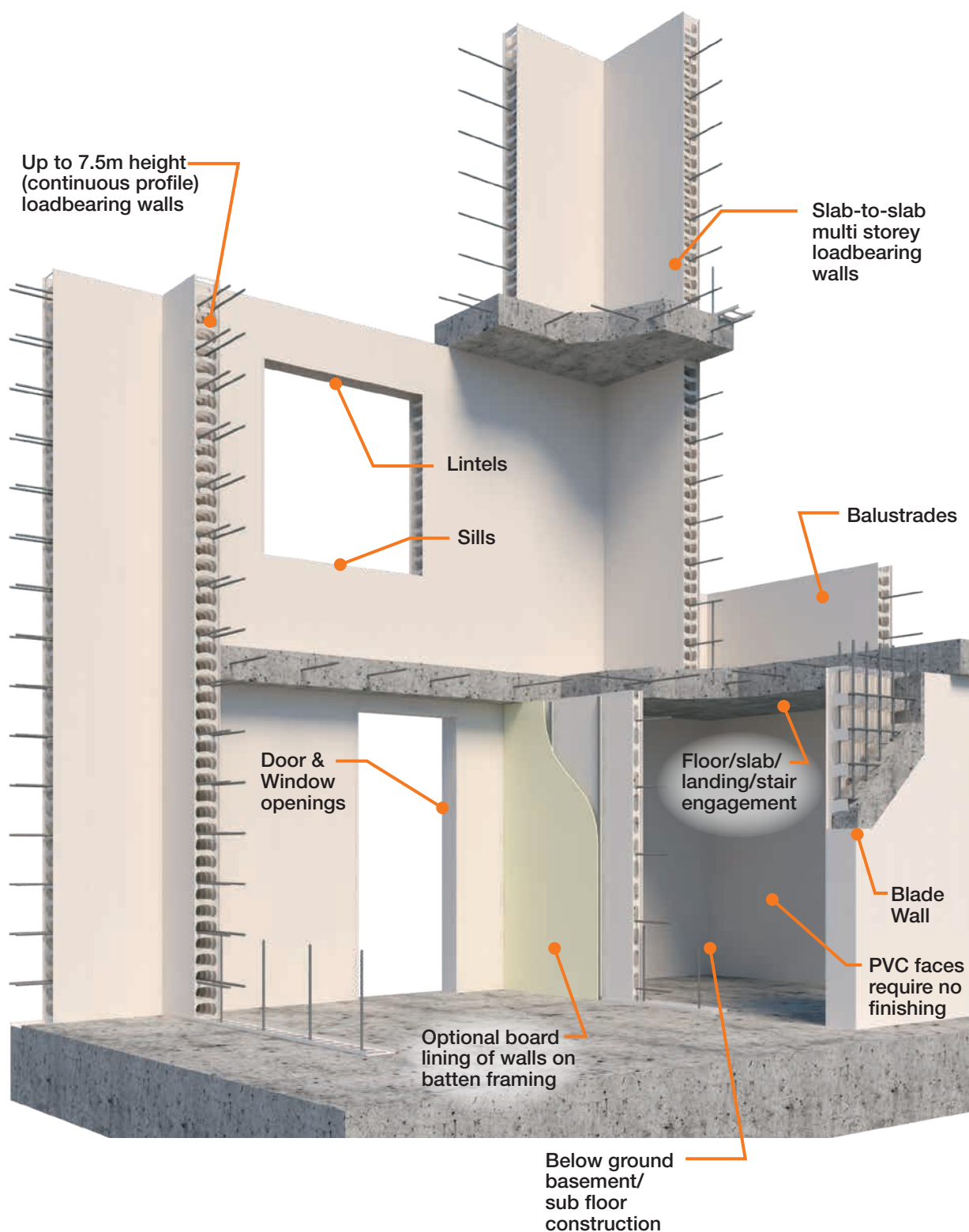

Note: If rediwall® is exposed to UV, appropriate protective finish shall be applied.

**Rediwall®
Party walls**

**Rediwall®
Boundary walls**

**Rediwall®
Corridor walls**

**Rediwall®
Balustrades**

**Rediwall®
Garden/Landscape
walls**

**Rediwall®
Retention Tanks**

**Rediwall®
Basement walls**





**Rediwall®
Façade walls**

**Rediwall®
Balustrades**

**Rediwall®
Blade walls**

**Rediwall®
Lift & Stair shafts**

**Rediwall®
Retaining walls**

**Rediwall®
Blade walls**

Rediwall® Product Description

Rediwall® consists of extruded rigid PVC components that serve as a permanent formwork for cast in-situ concrete walls for a large range of applications. The extruded components slide and snap together to create a PVC formwork that remains in place after the concrete is poured and cured, providing a low maintenance, finished wall surface.

The AFS Rediwall® system allows for the panels to be installed from the concrete slab which accommodates the vertical walls being built prior to the horizontal formwork being installed

The available rediwall® types are identified in the following table:

TABLE A1: Rediwall® Systems Overview

AFS Rediwall®		OVERALL THICKNESS (NOMINAL)	CONCRETE CORE (INTERNAL CAVITY)	FILLED MASS (kg/m ²)	UNFILLED MASS (kg/m ²)	PVC WALL THICKNESS (mm)
Clip System	RW110C	110mm	105mm	260	11.18	2.4
	RW156C	156mm	151mm	375	11.12	2.4
	RW200C	200mm	195mm	480	12.49	2.4
Slide System	RW256S	256mm	251mm	620	17.12	2.4





Rediwall® System Benefits



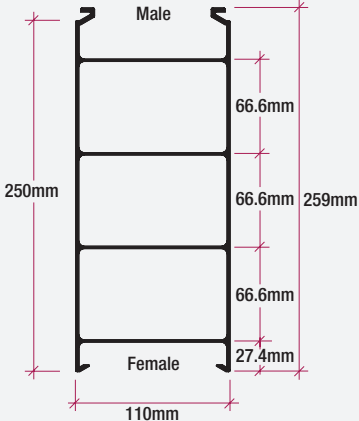
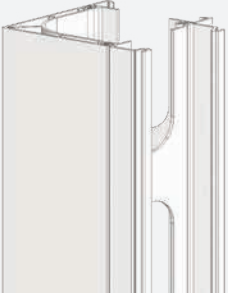
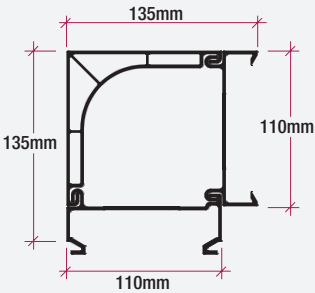
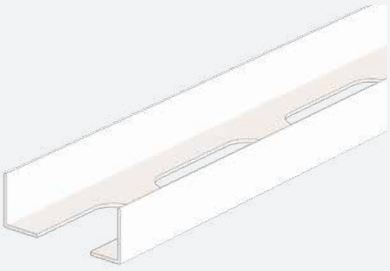

With an increasing demand throughout the construction industry for faster and more efficient building methods, rediwall® has gained rapid acceptance in the market place due to the range of benefits it offers developers, designers and builders, including:

- Cost efficiency
- Speed of construction
- Ease of installation and materials handling
- Low maintenance and aesthetically appealing finish
- NCC compliant
- Water resistant
- Design versatility



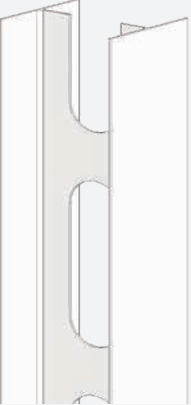
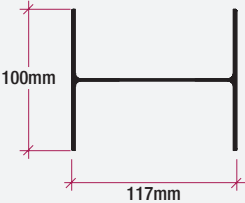

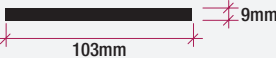

COMPONENTS, TOOLS & ACCESSORIES

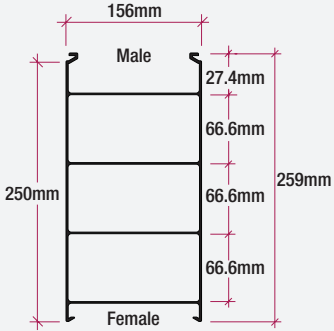

Components for RW110C System

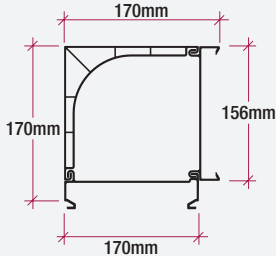

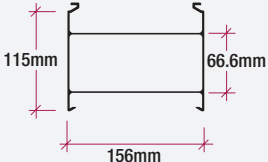
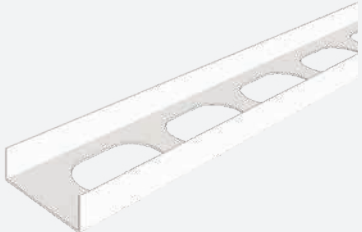
RW110C Panel		Description
		An extruded PVC panel used to form the main body of a wall. Adjoining panels are fitted using the male to female clip-in system. Each panel is extruded to a surface tolerance of 1.5mm. Has 4 internal webs with oval holes for single reo bar placement. For m ² calculation, face width is 250mm.
RW110C Corner Assembly		Description
		A three piece PVC panel that forms a corner between walls meeting at 90°. Designed to allow for removal of the outside 90° corner cap for easy placement and inspection of internal reinforcement. Cap is refitted for concrete filling. Adjoining panels are fitted using the male to female clip-in system.
Floor Track		Description
		A PVC track used to set the bottom line of the wall. Laid flat, the floor track has large holes for starter bars, etc. The sides are for both locating the panels and for screw fixing to the bottom of the panels.
T joiner		Description
		A PVC extrusion used to start a T-wall from a through wall, where the T-wall is close to 90°. Fixed vertically to the face of the through wall. Has holes in its face to assist alignment when drilling the through wall for reo bar placement. Adjoining panels are fitted using the male to female clip-in system.

H joiner		Description
		<p>A slide-on PVC extrusion.</p> <p>Primarily used horizontally on external walls where it is laid along the straightened top of panels to act as a bottom track for the next level of panels.</p> <p>Also used vertically as a wall make-up piece. Can be slid into a gap in the wall of 50mm or less and screw fixed to adjoining panels.</p>
Slide on End Cap		Description
		<p>A slide-on PVC extrusion for capping off wall ends and openings. Fixed on each side with screws and/or glue. Can be installed before or after wall is filled. Adequate bracing must be provided.</p>
Fibre Cement Strip		Description
		<p>A fibre cement strip, for closing off wall ends, where a simple shutter is required. Cut to length on-site, the strip slides in behind the female clip end of the panel (or alternatively behind a web). Can also be use as a pour break. Adequate bracing must be provided.</p>

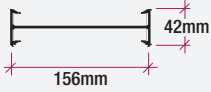
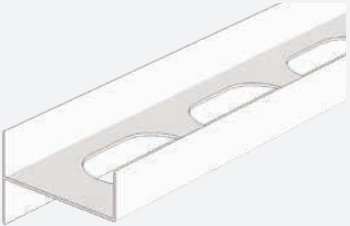
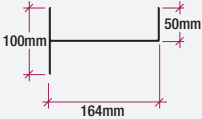
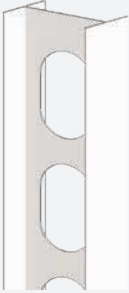
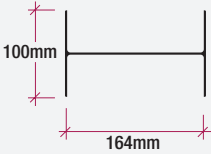

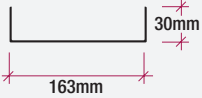

Components for RW156C System





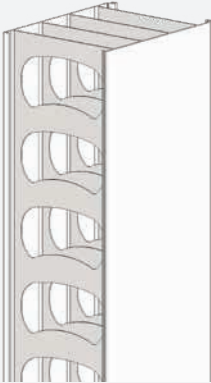
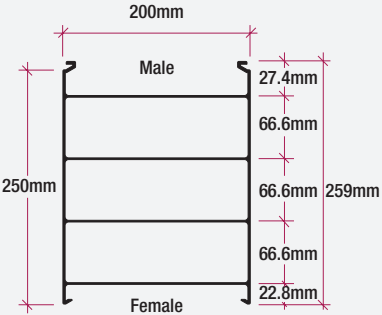
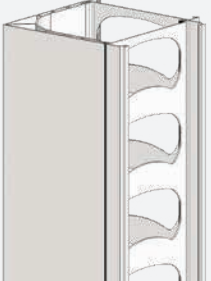
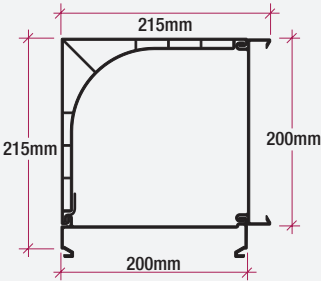
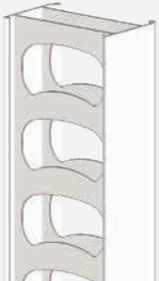

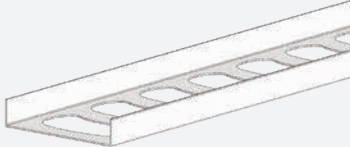
RW156C Panel	Description	Description
		<p>An extruded PVC panel used to form the main body of a wall. Adjoining panels are fitted using the male to female clip-in system. Each panel is extruded to a surface tolerance of 1.5mm. Has 4 internal webs with oval holes for single reo bar placement. For m² calculation, face width is 250mm.</p>
RW156C Corner Assembly	Description	Description
		<p>A three piece PVC panel that forms a corner between walls meeting at 90°. Designed to allow for removal of the outside 90° corner cap for easy placement and inspection of internal reinforcement. Cap is refitted for concrete filling. Adjoining panels are fitted using the male to female clip-in system.</p>
115mm Spacer	Description	Description
		<p>An extruded PVC panel used to adjust the length of a wall. Adjoining panels are fitted using the male to female clip-in system. Used primarily close to the closure of a wall, Has 2 internal webs with oval holes for single reo bar placement. For m² calculation, face width is 115mm.</p>
Floor Track	Description	Description
		<p>A PVC track used to set the bottom line of the wall. Laid flat, the floor track has large holes for starter bars, etc. The sides are for both locating the panels and for screw fixing to the bottom of the panels.</p>



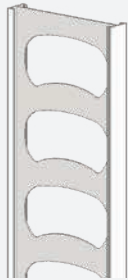

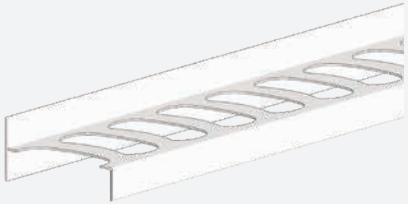
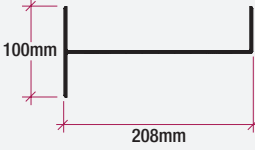
Female/Female Joiner		Description
		<p>An extruded PVC joiner used to reverse a male panel end to a female panel end. For m² calculation, face width is 42mm.</p>
J Track		Description
		<p>A slide-on PVC extrusion primarily used horizontally on external walls where an edge-form slab is to be formed. It is laid along the straightened top of panels to act as a bottom track for the next level of panels and to assist with edge-form preparation.</p>
H Joiner		Description
		<p>A slide-on PVC extrusion primarily used horizontally on external walls where it is laid along the straightened top of panels to act as a bottom track for the next level of panels.</p> <p>Also used vertically as a wall make-up piece. Can be slid into a gap in the wall of 50mm or less and screw fixed to adjoining panels.</p>
T Joiner		Description
		<p>A PVC extrusion that is fixed vertically to the face of a through wall to start a T-wall, where the T-wall is close to 90°. Has holes in its face to assist alignment when drilling the through wall for reo bar placement. Adjoining panels are fitted using the male to female clip-in system.</p>

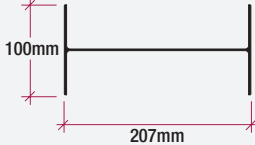
Slide on End Cap		Description
		<p>A slide-on PVC extrusion for capping off wall ends and openings. Fixed on each side with screws and/or glue. Can be installed before or after wall is filled. Adequate bracing must be provided.</p>
Fibre Cement Strip		Description
		<p>A fibre cement strip, for closing off wall ends, where a simple shutter is required. Cut to length on-site, the strip slides in behind the female clip end of the panel or joiner (or alternatively behind a web). Can also be use as a pour break. Adequate bracing must be provided.</p>







Components for RW200C System

RW200C Panel	Description	Description
		<p>An extruded PVC panel used to form the main body of a wall. Adjoining panels are fitted using the male to female clip-in system. Each panel is extruded to a surface tolerance of 1.5mm. Webs have kidney shaped holes for single, or double reo bar placement by inverting the panel. Holes must be kept in horizontal alignment. For m² calculation, face width is 250mm.</p>
Corner Assembly	Description	Description
		<p>A three piece PVC panel that forms a corner between walls meeting at 90°. Designed to allow for removal of the outside 90° corner cap for easy placement and inspection of internal reinforcement. Cap is refitted for concrete filling. Adjoining panels are fitted using the male to female clip-in system.</p>
115mm Spacer	Description	Description
		<p>An extruded PVC panel used to adjust the length of a wall. Adjoining panels are fitted using the male to female clip-in system. Used primarily close to the closure of a wall. Has 2 internal webs with kidney shaped holes for single, or double reo bar placement by inverting the panel. For m² calculation, face width is 115mm.</p>
Floor Track	Description	Description
		<p>A PVC track used to set the bottom line of the wall. Laid flat, the floor track has large holes for starter bars, etc. The sides are for both locating the panels and for screw fixing to the bottom of the panels.</p>

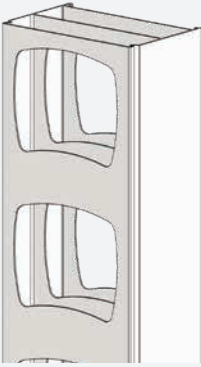
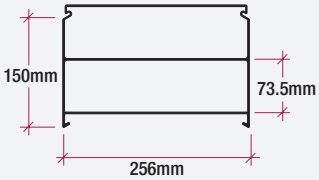
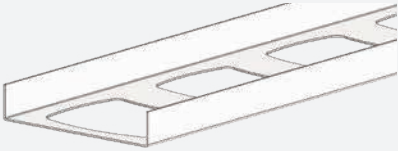

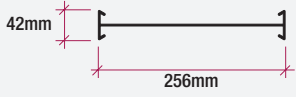

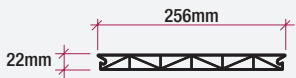
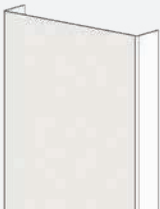
Female/Female Joiner		Description
		An extruded PVC joiner used to reverse a male panel end to a female panel end. For m ² calculation, face width is 42mm.
J Track		Description
		A slide-on PVC extrusion primarily used horizontally on external walls where an edge-form slab is to be formed. It is laid along the straightened top of panels to act as a bottom track for the next level of panels and to assist with edge-form preparation.
H Joiner		Description
		A slide-on PVC extrusion. Primarily used horizontally on external walls where it is laid along the straightened top of panels to act as a bottom track for the next level of panels. Also used vertically as a wall make-up piece. Can be slid into a gap in the wall of 50mm or less and screw fixed to adjoining panels.
T Joiner		Description
		A PVC extrusion that is fixed vertically to the face of a through wall to start a T-wall, where the T-wall is close to 90°. Has holes in its face to assist alignment when drilling the through wall for reo bar placement. Adjoining panels are fitted using the male to female clip-in system.

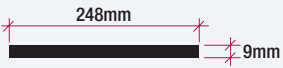
Slide on End Cap		Description
		<p>For capping off wall ends and openings. A slide on connection with a 40mm side for fixing with screws or glue. Can be installed before or after wall is filled. Must be propped when filling, if a flat end is required.</p>
Fibre Cement Strip		Description
		<p>A fibre cement strip, for closing off wall ends, where a simple shutter is required. Cut to length on-site, the strip slides in behind the female clip end of the panel or joiner (or alternatively behind a web). Can also be use as a pour break. Adequate bracing must be provided.</p>

Components for RW256S System

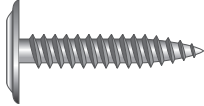
RW256S Panel		Description
		An extruded PVC panel used to form the main body of a wall. Adjoining panels are fitted using the male to female slide in coupling system. Each panel is extruded to a surface tolerance of 1.5mm. Webs have arched rectangular holes to accept double reo with appropriate concrete cover. Panels are joined by male to female slide in coupling. For m ² calculation, face width is 150mm.
Floor Track		Description
		A PVC track used to set the bottom line of the wall. Laid flat, the floor track has large holes for starter bars, etc. The sides are for both locating the panels and for screw fixing to the bottom of the panels.
Female/Female Joiner		Description
		An extruded PVC joiner used to reverse a male panel end to a female panel end. For m ² calculation, face width is 42mm.
Quick Cap		Description
		A slide-on PVC extrusion for capping off wall ends and openings. Adequate bracing must be provided.
Slide On End Cap		Description
		A slide-on PVC extrusion for capping off wall ends and openings. Adequate bracing must be provided.
Fibre Cement Strip		Description
		A fibre cement strip, for closing off wall ends, where a simple shutter is required. Cut to length on-site, the strip slides in behind the web of an end panel. Can also be use as a pour break. Adequate bracing must be provided.

Tools & Accessories

Screws	Description
	<p>Button head stitching screw 10G x 25mm, for joining of rediwall® components.</p>
Wall Brace	Description
	<p>Adjustable wall bracing is available from AFS for purchase. Contact afs for further information.</p>
Squint Angle	Description
	<p>Powder coated metal squint angle 150 x 150mm at 135° Used to form 45° wall corners.</p>
Floor Angle	Description
	<p>Galvanised metal floor angle 50 x 50mm at 90°. Used to set the bottom line of the wall. Laid flat, and set at a distance apart to match the wall sized used. The sides are for both locating the panels and for screw fixing to the bottom of the panels</p>

Workplace Health Safety and the Environment

AFS rediwall® has been designed with workplace health safety and the environment in mind. Issues regarding installation have been considered so that the risk of harm to those who build, use and maintain the structure is minimised.

A vital consideration when planning installation, is to have appropriate safe systems of work to identify hazards, assess risks, control risks and to ensure a process to review control measures.

Assessing the hazards associated with the installation methods, equipment, chemicals, tools, trades, and work environment is the responsibility of both the builder and installer.

Appropriate assessment of risk, adequate resources, communication methods and training provided to workers is to be considered and documented for each site location.

AFS has documented sample safe work methods that can be accessed upon request as REFERENCE MATERIAL ONLY. This can be provided as an aid to builders and installers when risk assessing the work, and when developing documentation.

Consultation and training of workers in agreed safe methods will always be the builders and installers responsibility.

For further information please visit SafeWork Australia <https://www.safeworkaustralia.gov.au/risk>

Personal Protective Equipment

The Personal Protective Equipment required may vary from site to site and from time to time, and it is the responsibility of every individual to ensure that they use the appropriate equipment to safeguard themselves and those around them.

A basic protective kit should include, but not necessarily be limited to:

- Dust mask
- Safety gloves
- Hearing protection
- Sunscreen cream/lotion
- Eye protection

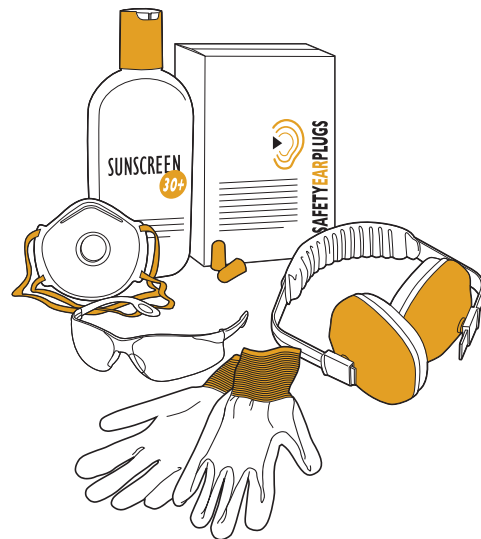

Hand Tools Required

To safely and efficiently complete any task, it is essential to have the necessary tools available and to use the right tool for the right task.

A typical range of hand tools would include, but not be limited to the following:

- Tool bag/belts
- Cutting knife
- Handsaws
- Hammers - 'claw' and 'gympie'
- Pencils, marking pens, chalk
- Variety of pliers
- A range of squares
- String and chalk lines
- Tape Measures – eg. 8m and 3m
- Spirit levels – range of lengths eg. 600mm and 2000mm
- Plumb Bob
- Laser leveling equipment



Access Tools

All scaffolding and safe access provisions are the responsibility of the builder and installers and are governed by the individual site conditions. It is essential that safe work practices and all associated standards are met/complied with. Installers would normally provide a range of platforms for personal access to the top of wall panels for the fitting of braces and checking of stringlines.

Power Tools

There are a range of power tools required during installation of afs rediwall®. Wherever possible preference should be given to cordless tools.

Note: All power tools require tagging as per site requirements.

Suggested power tools and applications include:

- A 'charge gun', such as the 'Hilti GX120' with appropriate fixings to pin the floor track to the concrete slab.



Hilti GX120

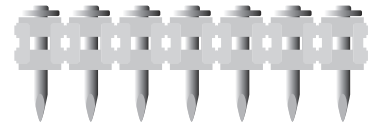

- A screw driver gun, with appropriate driver bits and screws for fixing rediwall® panels to track and adjacent panels or form deck. Also used to fixing bracing.



- A range of grinders and circular saws for cutting components and timbers for bracing.



Concrete Pouring & Finishing Tools

- Concrete pouring and finishing tools, including:
 - At least one wheelbarrow, multiple shovels and a range of trowels.
 - Concrete vibrator: 40mm diameter maximum.



THE CONSTRUCTION PROCESS

Construction Process Overview

1 Place Order

Client completes rediwall® order form, listing lineal metres of each wall height required, and selecting any accessories required. The completed order form is submitted to afsorders@csr.com.au electronically or by fax on 1300 715 237.

Introducing the rediwall® ordering app... an easier way to order.

For fast, convenient ordering why not place your order via the rediwall® ordering app. Just a few quick taps tells us what you want and where you want it, an easier hassle-free way to place your order anytime from anywhere.

To access the rediwall® app simply download it from the App Store. (Android version coming).

Once you've downloaded the App you'll be asked to input your account name and number as a one-off registration.

Should you need assistance with obtaining your account number, please call our customer service team on 1300 727 237

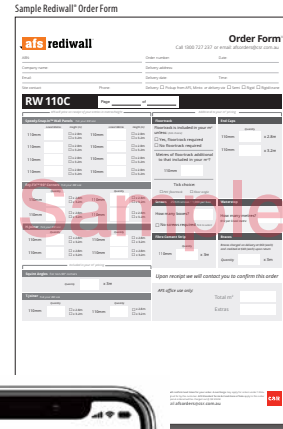

Sample Rediwall® Order Form

afs rediwall® Order Form™
Call 1300 727 237 or email afsorders@csr.com.au

Customer Name: _____
Company Name: _____
Address: _____
City: _____ State: _____ Postcode: _____
Phone: _____ Email: _____
Project Name: _____
Project Address: _____
Project Postcode: _____

RW 110C

Line	Description	Quantity	Unit	Notes
1	110C		m	
2	156C		m	
3	200C		m	
4	256C		m	

Order Form Summary

Total m: _____
Total m²: _____
Extra: _____

Open message and self contact you to confirm this order

afs orders only



2 Production

AFS Rediwall® is manufactured in a state of the art factory with precision processes, manufacturing large volumes of quality product with short lead times.



3 Delivery

AFS's in house transportation and logistics team ensure that orders are shipped with care, arriving on site in a timely manner. Panels are shipped in packs of up to approximately 20 panels for RW110C, 20 for 156C, 20 for RW200C and 24 for RW256S, which are easily delivered to site and craned onto the floor slab or deck ready for placement.



Construction Process Overview – Continued

4 Site Erection

Once set-out is complete, rediwall® floor track is installed, followed by the rediwall® panels being lifted into place by hand over the reinforcement starter bars. In some cases it is simply installed off the formwork deck of the next floor level. The panels are then braced using temporary bracing or fixed to the formwork deck.



5 Openings & Services

Smaller penetrations may be cut out once the formwork is installed and then capped off using the rediwall® End Cap. Doorway and window openings are formed using sill and lintel panels which can be supplied cut to size. Steel door frames can be installed to suit, or the openings can simply be capped off using the rediwall® End Cap.



6 Concrete Core Fill

The erected panels are then core filled with concrete using a mix design that is suitable for filling rediwall®, via a concrete pump. This is mostly done from the formed deck of the next slab or off a scaffold. Refer to concrete core fill procedure.



7 Finishing of Walls

Once the concrete core fill has gained strength and the walls are permanently braced by the floor or roof structure at the top of the walls, the temporary bracing is removed. The smooth, off white finish of the rediwall® panels is a suitable finish for many applications, refer to Volume 2 – "Wall Construction Detailing & Finishing Treatments Guide" for specific finishes for rediwall®.

Suitable paints or renders can be applied to the surface if required. Please contact Dulux Acratex, Rockcote or equivalent render suppliers, for their warranted specifications on the rediwall® substrate.



Ordering

Ordering of rediwall® is a simple process requiring a rediwall® Order Form to be completed by the appropriate project personnel and submitted to the rediwall® production team.

A sample of the form is shown below. An interactive PDF form can be downloaded from www.afsformwork.com.au/rediwall-order-form completed digitally and then emailed to – afsorders@csr.com.au

Alternatively a printable form can be downloaded at www.afsformwork.com.au/rediwall-order-form completed and returned by email as above or faxed to 1300 715 237.

Lengths and heights of walls, derived from project

construction drawings, are inserted into the rediwall® order form along with the quantities of accessories, such as: corners, end caps, floor track and H-sections.

To avoid delays during erection, it is recommended that additional rediwall® components are ordered. Additional quantities ordered should be based on project size, construction schedule, site proximity to the rediwall® supply facility, the potential for damage on site and the potential for site modifications.

On completion and submission of your order form you will receive a confirmation detailing exactly what has been entered into the production system. It is the customers responsibility to check this confirmation for accuracy and advise AFS of any errors immediately.

How to order

- 1 Complete your company details, make sure to include the correct site contact details.
- 2 Complete your order number, delivery address and your requested delivery date.
- 3 Calculate the total linear metres required and the height of the panels you require. All accessories are supplied at stock length.
- 4 Add quantities of Squint Angles and T junctions if required.
- 5 Select your floor track option and quantity.
- 6 Enter the quantity of end caps, screws, braces and fibre cement strips you will need.
- 7 Submit your form and AFS will contact you for order confirmation before processing your order. Check the confirmation email from AFS for accuracy.

Introducing the rediwall® ordering app... an easier way to order.

For fast, convenient ordering why not place your order via the rediwall® ordering app. Just a few quick taps tells us what you want and where you want it, an easier hassle-free way to place your order anytime from anywhere.



Sample Rediwall® Order Form

afs rediwall

Order Form^{v4}
Call 1300 727 237 or email: afsorders@csr.com.au

ABN: _____

Order number: _____

Date: _____

Company name: _____

Delivery address: _____

Email: _____

Delivery date: _____

Time: _____

Site contact: _____

Phone: _____

Delivery Pickup from AFS, Minto or delivery site Semi Right Rep/crane

RW 110C

Specify Snap-In™ Wall Panels Enter your RW size

Panel Metres	Height (m)	Panel Metres	Height (m)
110mm		110mm	
110mm		110mm	
110mm		110mm	
110mm		110mm	

Floor Track Floor track is included in your m² unless ticked below

Yes, floor track required
 No floor track required

Metres of floor track additional to that included in your m²:
 110mm _____

Tick choice:
 PVC floor track floor angle

End Caps

Quantity	Quantity
110mm _____	x 2.8m
110mm _____	x 3.2m

Screws 25mm screws - 1,000 per box

How many boxes? _____
 No screws required tick to select

Easy-Fit™ 90° Corners tick your RW size

Quantity	Quantity
110mm _____	x 2.8m x 3.2m
110mm _____	x 2.8m x 3.2m

H-joiners tick your RW size

Quantity	Quantity
110mm _____	x 2.8m x 3.2m
110mm _____	x 2.8m x 3.2m

Fibre Cement Strip

Quantity	Quantity
110mm _____	x 3m

Braces charged on delivery at \$60 (each) and credited at \$40 (each) upon return

Quantity _____ x 3m

Squint Angles For non-90° corners

Quantity _____ x 3m

T-joiners

110mm _____ x 3.2m

Upon receipt we will contact you to confirm this order

afs office use only:

Total m² _____

Extras _____

All prices exclude GST. Lead times from confirmation of your order. An AFS customer service representative will confirm lead times for your order. A surcharge may apply for orders under 100m² ordered for crane track delivery. AFS will not accept return of delivery products that have been approved and signed for by the customer. AFS Standard Terms & Conditions of Sale apply to this order. Empty available upon request. Quantity of floor track ordered over and above the linear metres (Lm) of wall panel ordered will be charged out @ \$8.50/Lm.

Questions? Call us on 1300 727 237 or email afsorders@csr.com.au

To access the rediwall® app simply download it from the App Store. (Android version coming).

Once you've downloaded the App you'll be asked to input your account name and number as a one-off registration.

Should you need assistance with obtaining your account number, please call our customer service team on 1300 727 237

CONSTRUCTION AND INSTALLATION PROCEDURES

This Installation Procedure Section has been prepared by AFS Systems Pty Ltd to assist builders, engineers and architects to understand the construction procedures for loadbearing and retaining walls using rediwall®.

The Installation Section provides information on the following aspects of construction using rediwall®:

- Ordering
- Delivery
- Wall set-out
- Establishing installation starting point
- Floor track/floor angle installation
- Installation of 90° corner
- Screw fixing of panels to floor track
- Installation of corner reinforcement
- Horizontal reinforcement placement
- Vertical reinforcement placement
- End caps
- Curved walls
- Tanking
- Bracing

Introduction

Although every effort has been made to ensure that all the information provided in this Installation manual is factual and consistent with good practice, AFS does not assume any liability for errors or oversights resulting from the use of information contained in this manual.

AFS highly recommends that the entire construction team are fully aware of the construction order and methods prior to commencement of wall installation.

Rediwall® consists of extruded rigid polymer components that serve as a permanent formwork for concrete walls in loadbearing and retaining applications. Popular uses include basement walls, retaining walls, retention tanks, foundation and landscaping walls, blade walls etc. The extruded components connect together to create formwork that remains in place after the concrete is poured and cured. This combination results in a strong concrete core wall with a low maintenance, finished wall surface.

Four rediwall® systems are available as shown in TABLE B1.

TABLE B1: Rediwall® Systems Overview

Rediwall® SYSTEM	WALL THICKNESS	
	OVERALL (NOMINAL)	CONCRETE CORE
RW110C	110mm	105mm
RW156C	156mm	151mm
RW200C	200mm	195mm
RW256S	256mm	251mm

Note: Concrete core thickness is calculated including manufacturing tolerance.

Component Delivery & Worksite Layout

Transport to site is typically arranged by AFS. Rediwall® packs are unloaded by a crane or forklift (provided by the builder), or crane truck (if requested at point of sale). Customers can also pick up with their own transport if prearranged. On delivery of the rediwall® components, place the packs strategically around the area where it is to be installed to minimise manual handling. Placement of packs should not interfere with locations for temporary wall bracing required during construction.

Rediwall® panels from 600mm to 7.5m can be supplied at the requested custom heights, suited to the specific project requirements and are listed on the delivery docket received with each delivery.

Using the pins/markings provided by the surveyor and the construction drawings, ensure the walls are clearly and accurately set-out. The builder should be responsible for this and should sign off on the set-out prior to commencement.

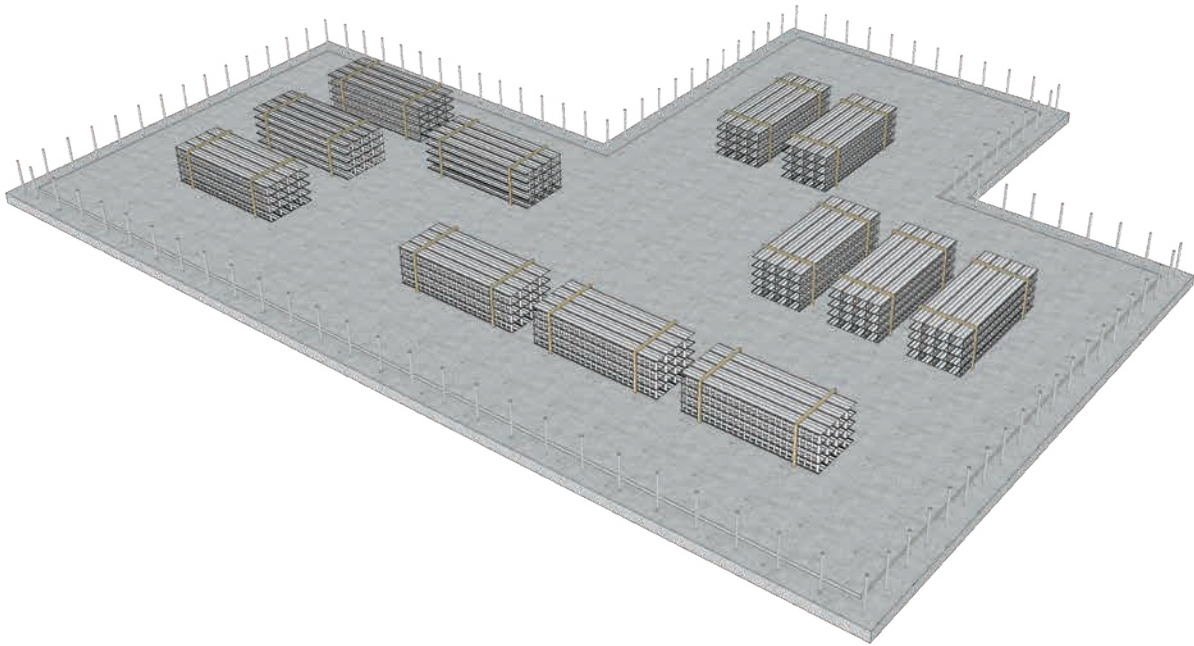

Floor/Wall Junction – Floor Track Installation

Introduction

Attention must be paid to the specified detailing of the horizontal slab/wall joint. Some projects have specific waterproofing requirements, such as installation of expandable Waterstop at the slab to wall junction.

WARNING: Rediwall® panels cannot be moved without demolition once filled with concrete.

Base Restraint

1. A continuous horizontal member is required at the base of the wall on at least one side of the rediwall® panels to hold the members straight and to prevent movement during core filling. This member is typically PVC floor track, however 40 x 40mm PVC angle installed on one side of the wall is acceptable.

2. The bottom restraining member may also act as formwork to cover any gaps at the underside of the wall due to irregularities in the surface of the footing or slab.

3. The bottom restraining member is to be fixed to the rediwall® components and anchored to the foundation as required by the Project Engineer's specifications.

4. Bottom restraining members fitted on one side of the wall are to be connected to the wall at 500mm maximum centres. For walls over 5m in height, the connection to the wall is to be at 250mm maximum centres.

Rediwall® PVC Floor Track

1 Starter bars should be set into the concrete as per engineering specifications. Corner bars should be set in the middle of the rediwall® corner profile.

2 Mitre the ends of the floor track so that the corner joins neatly.

3 Two beads of polyurethane sealant or as per waterproofers details, must be applied in accordance with the manufacturer's instructions under the rediwall® floor track (one on each side of the track) on all external walls, and any portion of a wall that separates or adjoins a wet area (e.g. bathroom, kitchen, or laundry).

4 Rediwall® floor track is then placed in the required location and fixed to the concrete footing or slab using a masonry fixing gun or drill and anchor masonry fixing system. Fix with fasteners each side of the track at 500mm centres for walls up to 5m height, or at 250mm maximum centres for walls over 5m height.

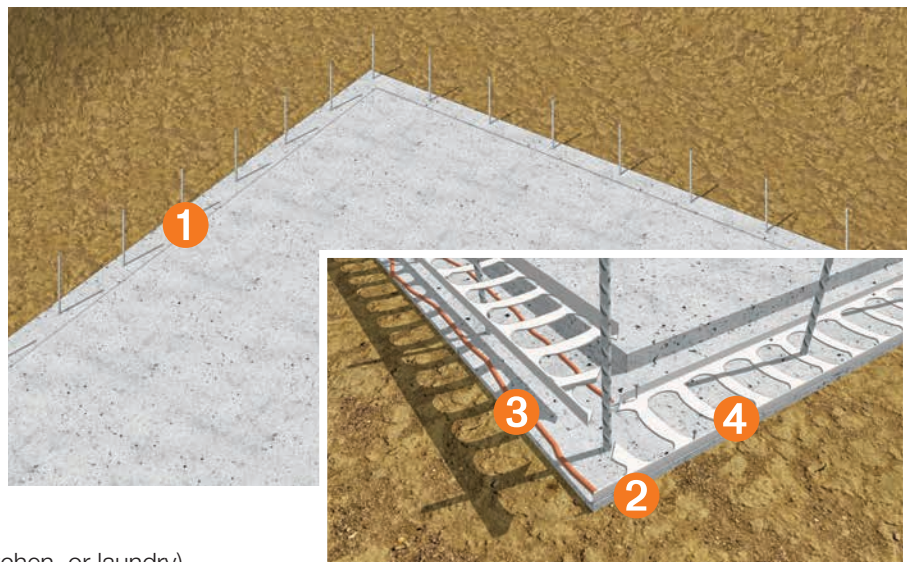

Water Treatment of Cold Joints

All waterproofing details are to be completed by the Project Builder and waterproofing contractor. When filled with concrete, rediwall® is a water resistant wall system. However specific areas requiring waterproofing details include horizontal concrete cold joints, and where water can track down along panel joints.

Any required waterproofing products must be installed strictly in accordance with the particular manufacturer's instructions.

- 1** Install afs rediwall® floor track as per the standard installation instructions.
- 2** Use an angle grinder to cut the floor track and remove the centre web. To create a continuous clear path for the waterstop.

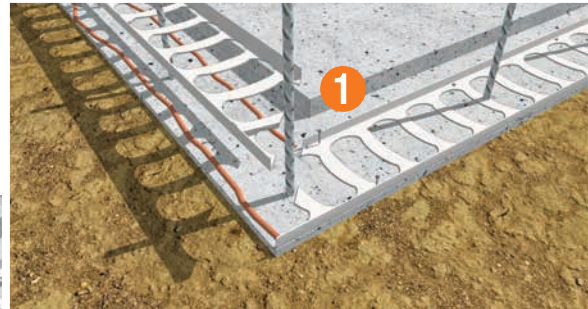
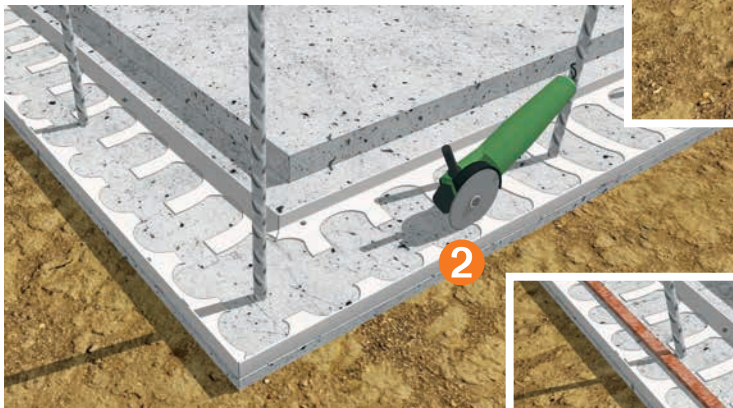

- 3** Install waterstop to manufacturer's instructions, maintaining a continuous seal. Refer to the project building designer for details on waterstop performance and installation requirements.

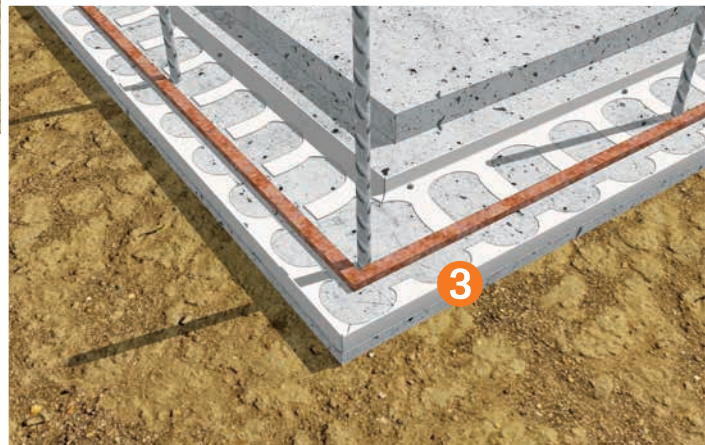

- 4** Install rediwall® panels over the water stop and fix to the floor track. Ensure that the panels DO NOT interfere with the waterstop.

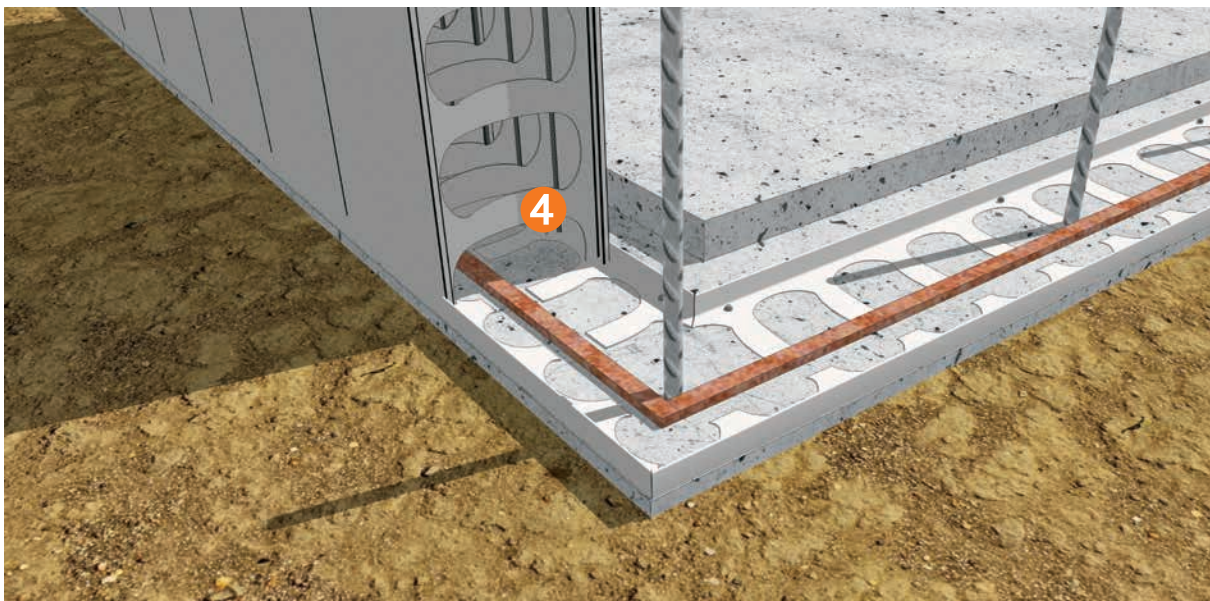

Control Joints

Movement Joints and Crack Control Joints

Rediwall® when completed as a structural reinforced concrete wall effectively had control joints at each web so no additional crack control joints are necessary.

Full depth "movement joints", when required, should be installed at construction stage by the rediwall installer. Refer to engineer's details for control joint locations.

- 1** Install afs rediwall® Female to Female joiner if required.
- 2** Slide Fibre Cement Strips down behind the female joiner end of the panel. Provide bracing across the joint with horizontal top hat brace as per the standard bracing details.
- 3** Once core fill has cured install a backing rod and fill the gap with a fire rated sealant, as per the sealant manufacturer's requirements.

NOTE: Optional doweling across the movement joint for lateral restraint can be incorporated, if required by engineer.

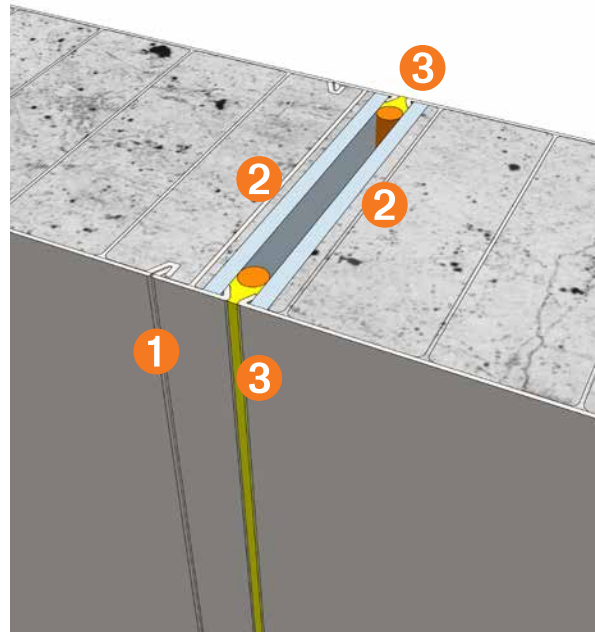

Starting Location

Introduction

It is important to consider the wall layout and to establish the best starting point and sequence in which to proceed with installation. This will help to ensure that the working space is kept as clear as possible.

Consideration should also be given to the positioning of bracing structures and minimising restriction of movement around the site. Refer to the Bracing section for details.

In the case of internal walls that are to be core filled off a mobile scaffold, it is preferable to run the braces in a way that leaves one face of each wall clear.

Once panel installation commences, consideration must be given to the timely installation of horizontal reinforcement.

WARNING

The individual components have a distinctive top and bottom orientation, which must be maintained in order for the web holes to be aligned. All panels are to be installed so that web holes are aligned horizontally.



Corner Construction

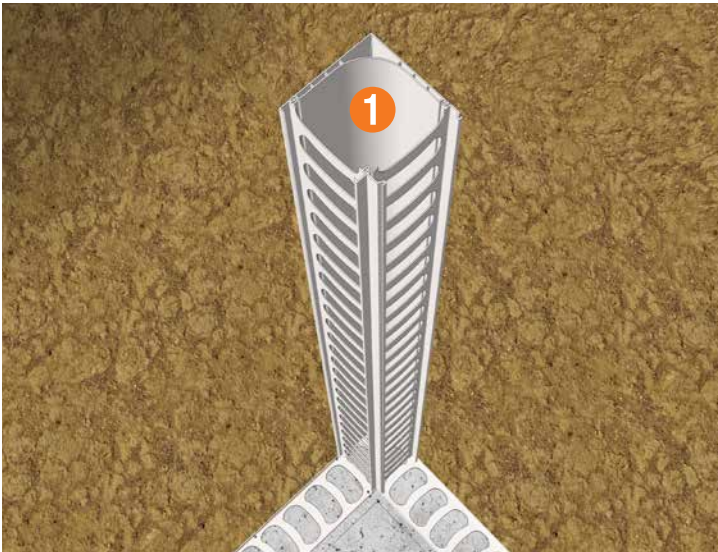

Corner Construction

- 1** Stand the corner assembly up and position on the floor track.
- 2** Install a wall panel either side of the corner assembly.
- 3** Screw fix the panels and the corner assembly to the floor tack.

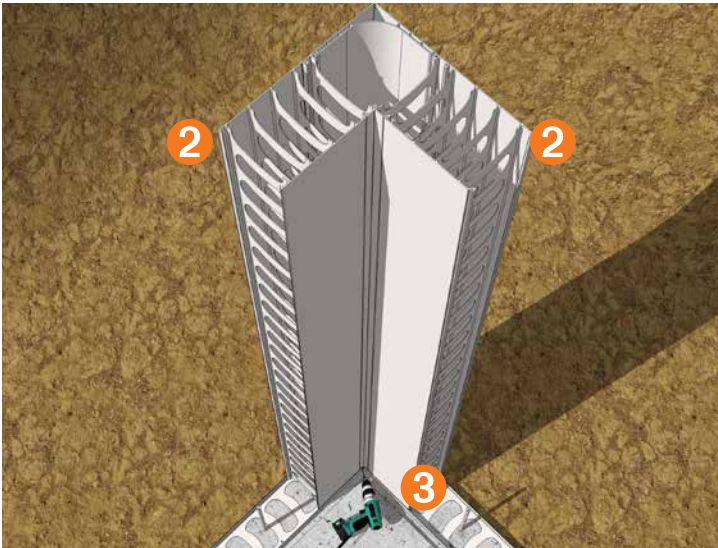

Wall Construction

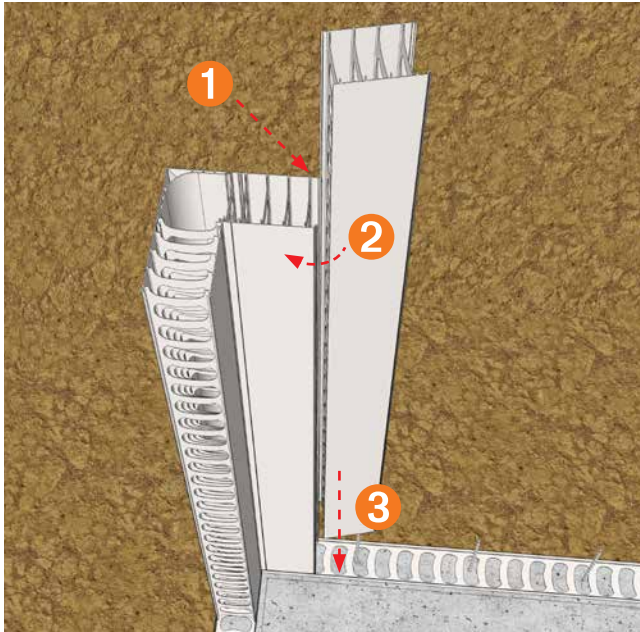

1 From your chosen starting location, hook one side of the rediwall® panel together making sure that the panel is above the slab starter bars.

2 Swing the rediwall® panel around and snap the opposite side into the preceding profile.

3 Slide the assembly down over the starter bars.

4 To avoid movement of the rediwall® panels during concrete core filling, install one screw each side of the panel through the floor track at the joint location. Ensure appropriate screw fixings are used to secure the panels.

Walls constructed using angle floor track should be fixed similarly.

5 Continue to install panels and accessories as required to complete the wall.

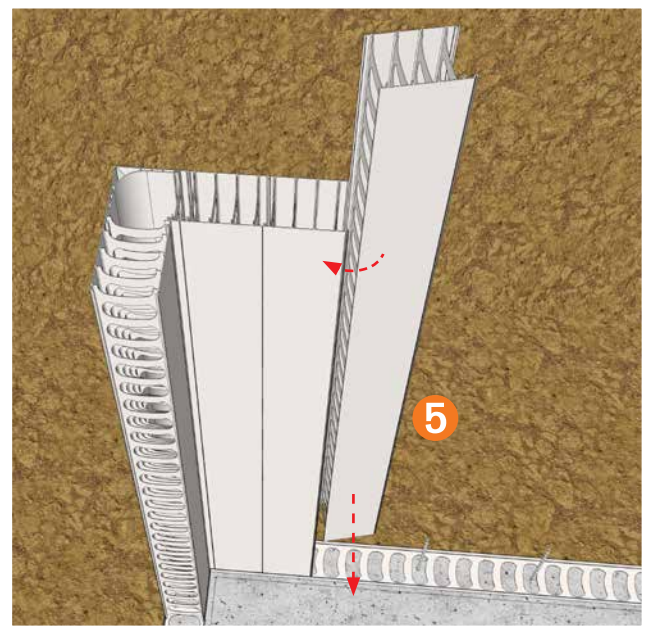
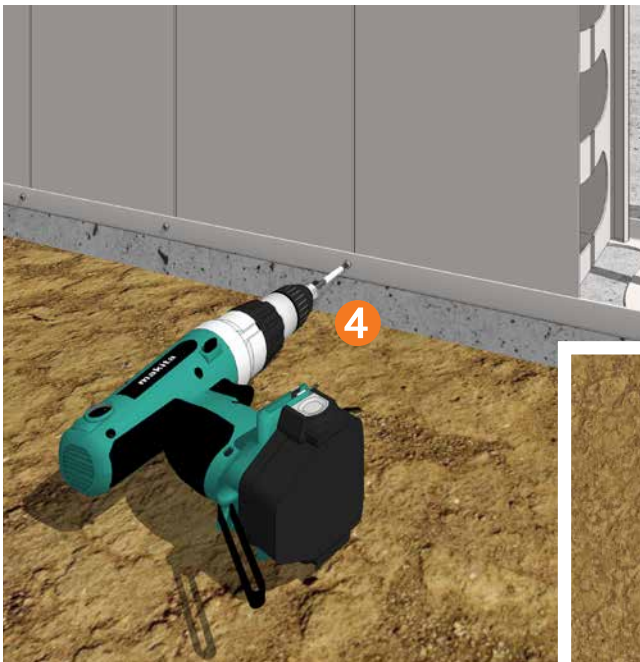

Wall Reinforcement

Reinforcement bar placement

Once a sufficient section of wall has been assembled, reinforcement should be installed.

It is important that reinforcement is installed in a uniform manner and that the correct spacings are maintained. This will help ensure correct concrete coverage.

- 1 Once the Rediwall® profiles are fixed in place, slide the horizontal reinforcement bars through the holes. The shape of the cut hole will help hold the bars in the correct position.

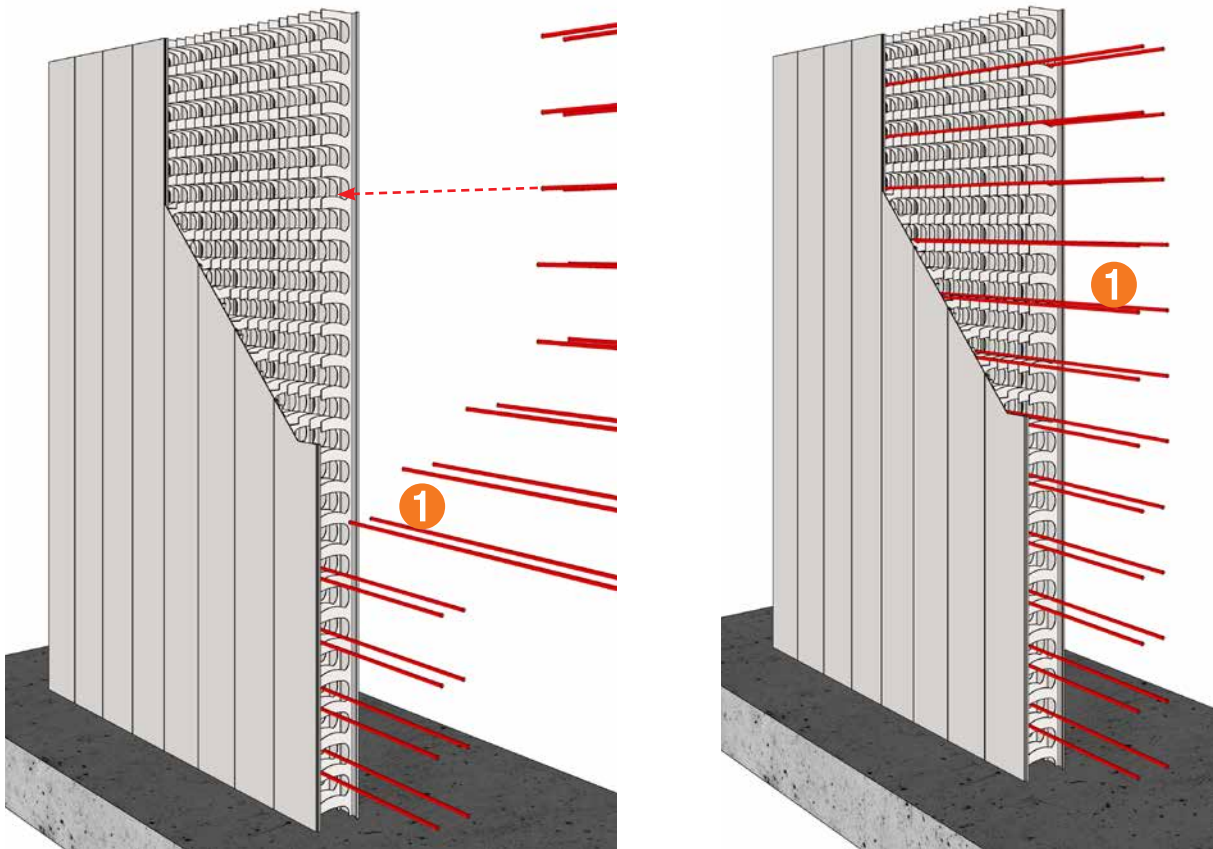

- 2** Install the vertical reinforcement as per the project specification. 'Weave' the vertical bars either side of the horizontal bars as shown.
- 3** Secure the top of the bars with an LVL timber or similar to space and lock the bars in position.

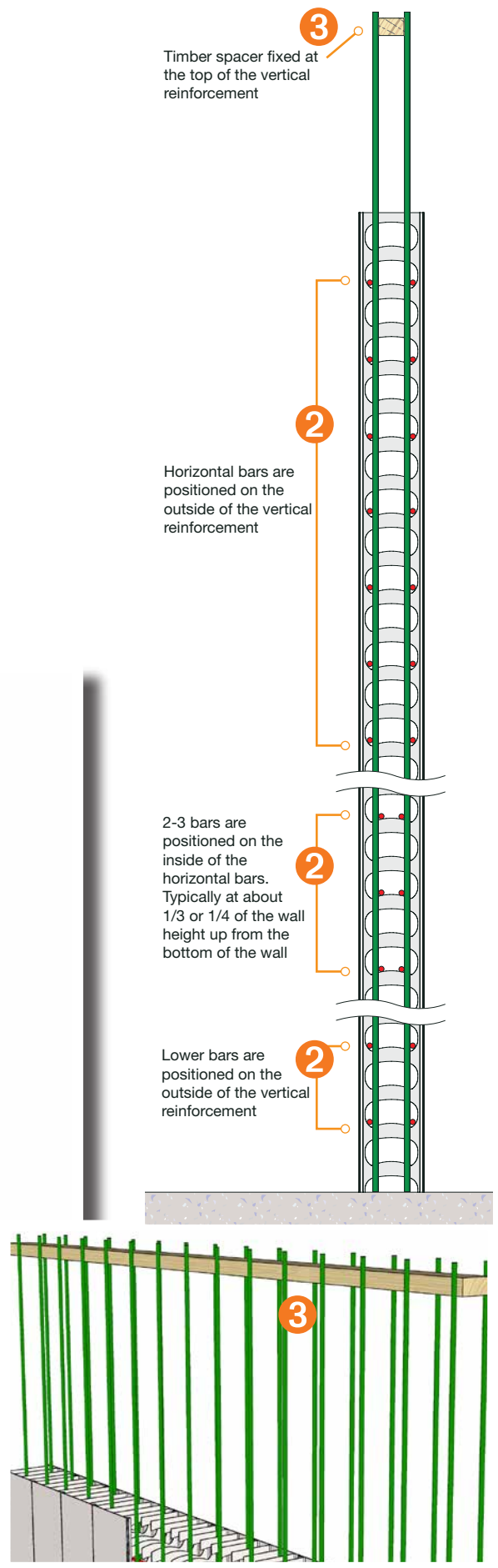
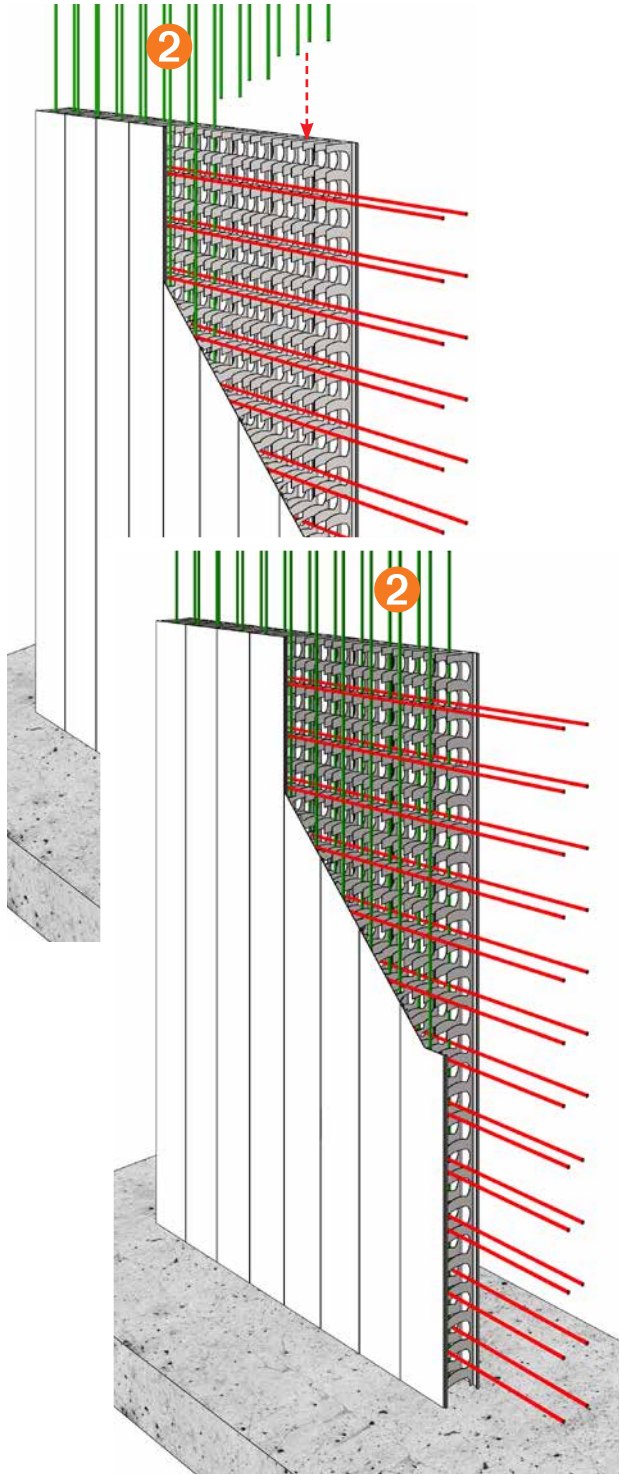

Corner Reinforcement

Installation of Corner Reinforcing Bars

Care is to be taken when installing horizontal reinforcement in corner units as a 'hook bar' and 'dropper' system is recommended.

Reinforcement must be placed in accordance with the project Structural Engineer's specifications

1 Install two or three rediwall® panels on each side of the corner, then insert the hook bar into the wall and slide it into the corner. Repeat this from the other side of the corner to form a loop in the corner.

2 Align the 'hook' on each hook bar in the corner and insert the vertical 'dropper bar' from the top of the corner panel and through the loops formed by the mating hook bars.

NOTE: Hook returns should be a minimum of 150mm to prevent the hook twisting in the cavity. (Panel bracing not shown for clarity.)

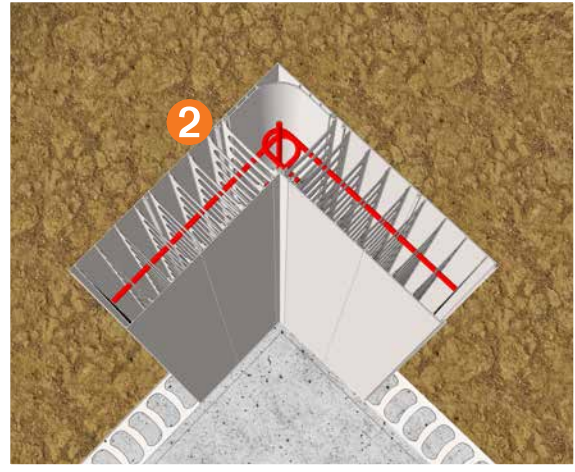
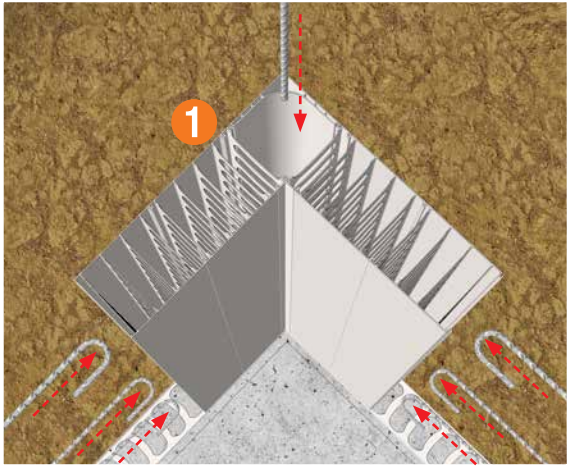
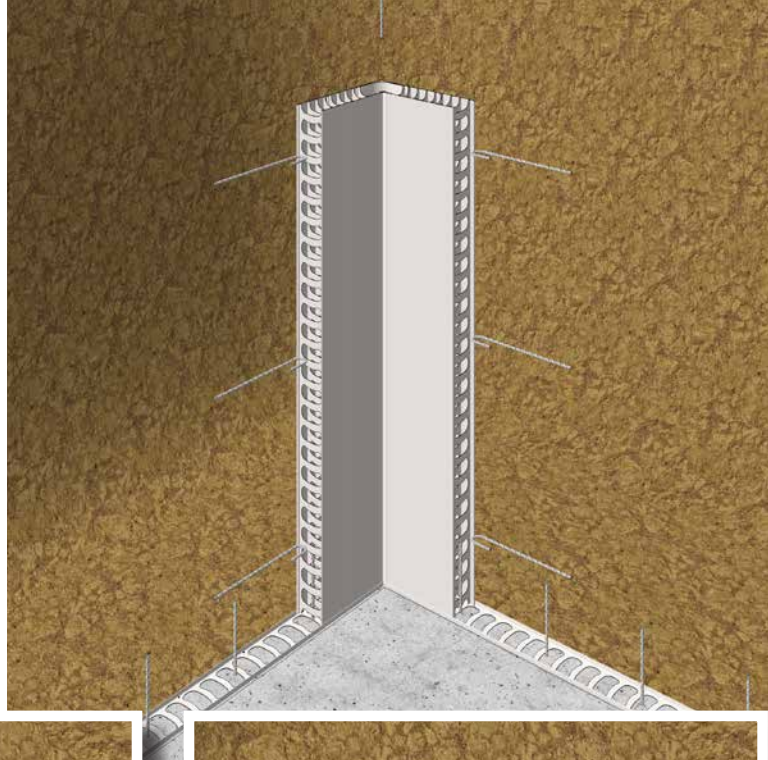

Corner Reinforcement - alternate method

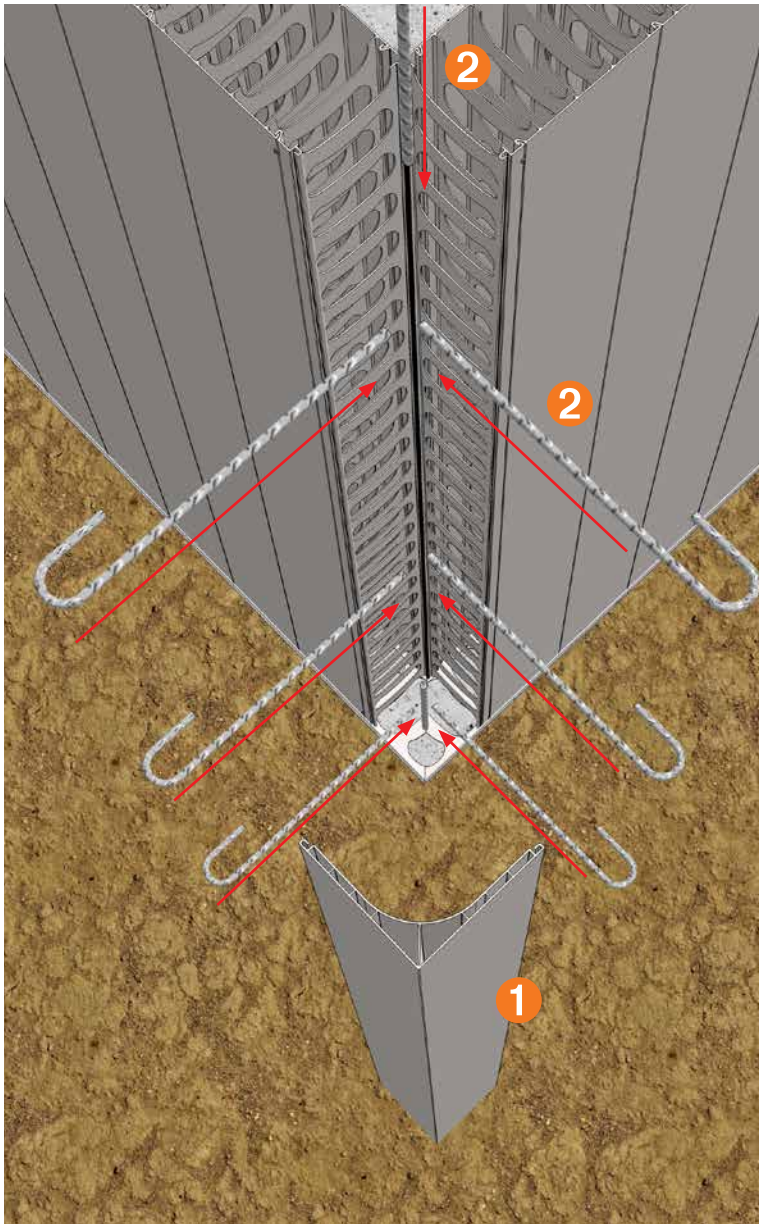

Installation of Corner Reinforcing Bars

When site access permits, reinforcing bars may be installed from the external wall side.

Reinforcement must be placed in accordance with the project Structural Engineer's specifications.

- 1** Remove the corner cap by sliding up and off the wall.
- 2** Align the 'hook' on each hook bar in the corner and insert the vertical 'dropper bar' from the top of the corner panel and through the loops formed by the hook bars.

Replace the corner cap ready for core filling.

Note: For short wall lengths, horizontal reinforcing can also be installed through the open corner.

Wall Construction

Full Height Panels

- 1** Install additional rediwall® panels by clipping each panel into the previous one and sliding it down into the floor track. This procedure is repeated to form a complete wall.
- 2** Plumb the wall section vertically, install bracing and fix each panel to the floor track as construction proceeds.
- 3** Wall sections are formed using full rediwall® panels. If a space of less than 250mm is left, spacers and H Joiners installed vertically can be used to make up the required distance. H Joiners can be used vertically for a gap of 50mm or less, screw fixed both sides at 150 centres to adjoining panels. Spacers are available in some systems, refer to the components page for availability.

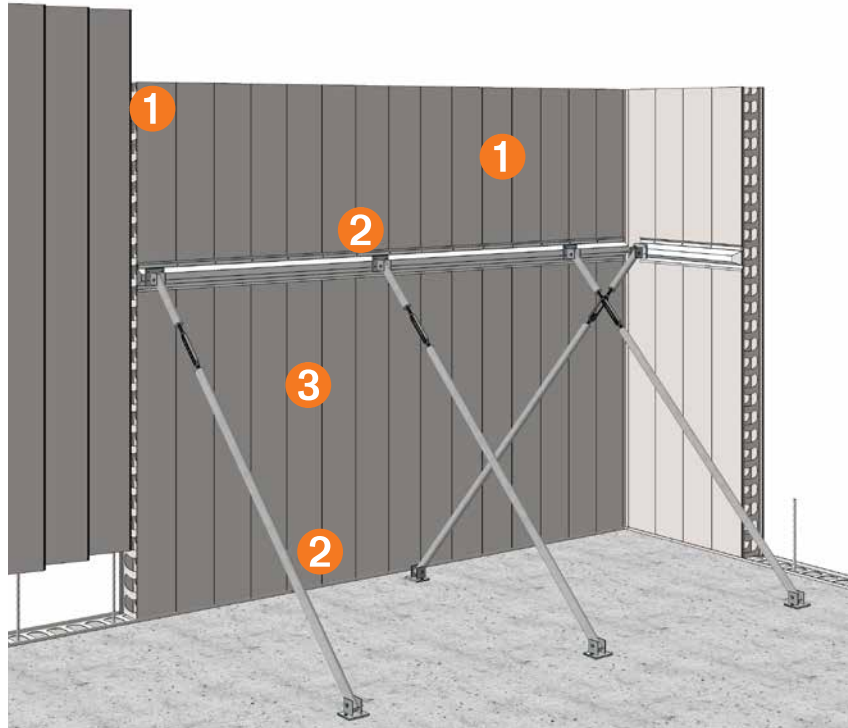

WARNING

Refer to the Bracing section for detailed requirements and methodology.

Safety Rail/Balustrade Wall Installation

Balustrade Wall

WARNING: Where rediwall® panels are to continue past a slab to form a balustrade, care shall to be taken when creating openings in the rediwall® panel face to ensure that the webs inside are not damaged causing the panels to be weakened.

- 1** Install the rediwall® panels as per the standard method.
- 2** Engagement of the wall and slab can be achieved by cutting holes in the rediwall® face to install reinforcing bars. Use a hole

saw as per Structural Engineer's details (100mm maximum diameter).

- 3** Insert the required reinforcement steel as per the Structural Engineer's details. When filling these safety rail/balustrade walls, fill initially to the bottom of slab level. Filling upper section shall be completed after the slab has been poured.

IMPORTANT: When being used as Safety Rail it is up to the Project Engineer to determine the required

specifications and ensure that all mandatory requirements are met.

Note: Care should be taken when core filling that no concrete loss occurs due to the opening of the panel face as this may create voids in the wall.

Extra bracing may be required to ensure panel stability during slab pour.



Steel Reinforcement Installation

Horizontal Reinforcement Installation

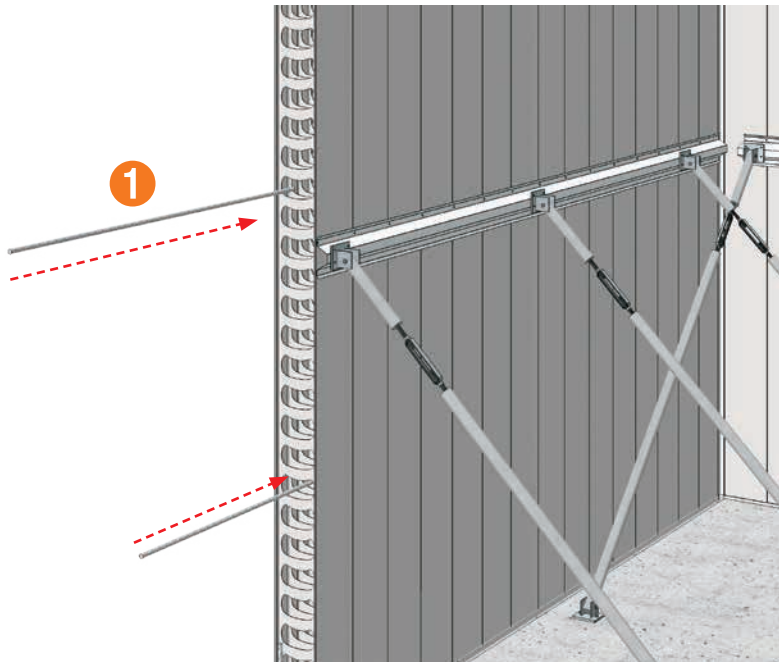

1 Horizontal reinforcement bars should be placed into the wall when it reaches a suitable length. Generally the wall is slightly longer than the steel bar length. Slide the reinforcement bar through the rediwall® profile ensuring that the bar will maintain the correct overlap with the previous and subsequent bars where applicable.

Refer to the Project Engineer's specifications for correct overlap and spacing of reinforcing bars.

Note: When panels are installed, ensure all webholes are aligned horizontally. Damage to webs inside can result in bulges when wall is filled with concrete.

Vertical Reinforcement Installation

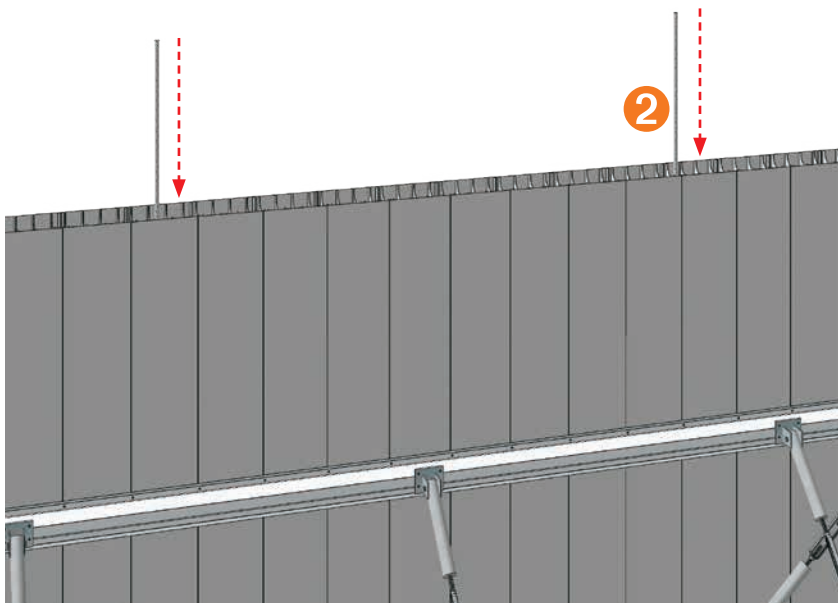

2 Vertical reinforcement bar should be placed vertically into the rediwall® profile, weaving between alternate horizontal bars. Ensure that the bar will maintain the correct overlap with the previous and subsequent bars where applicable.

Refer to the Project Engineer's specifications for correct overlap and spacing of reinforcing bars.

T Junction Construction

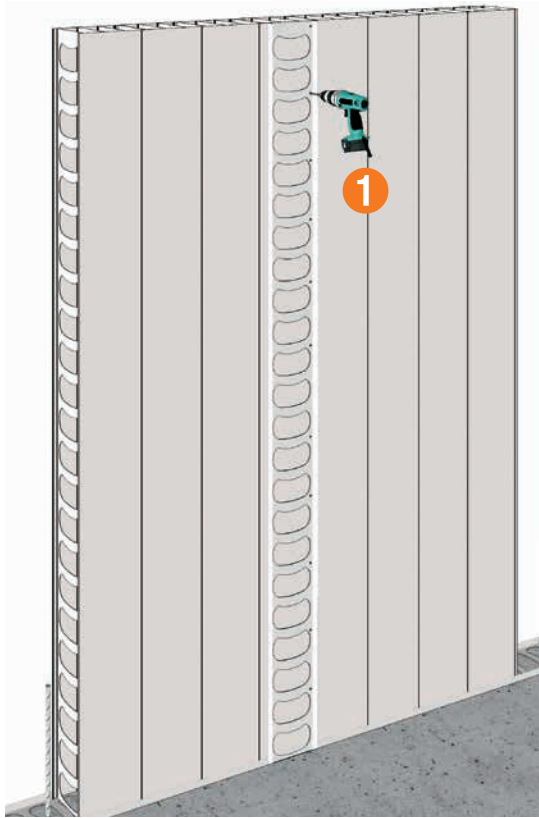

NOTE: Where a T-junction is to be formed, T-Joiner Track is to be used for vertical alignment. T-Joiner Track is used when core fill flow-through and reinforcement tie-in are required. If joining a male panel end at junction, use floor track in lieu of T-junction.

- 1 Place the T-Joiner Track vertically up the wall and fix the T-Joiner Track to the existing rediwall® panels with screws each side at 150mm vertical centres.

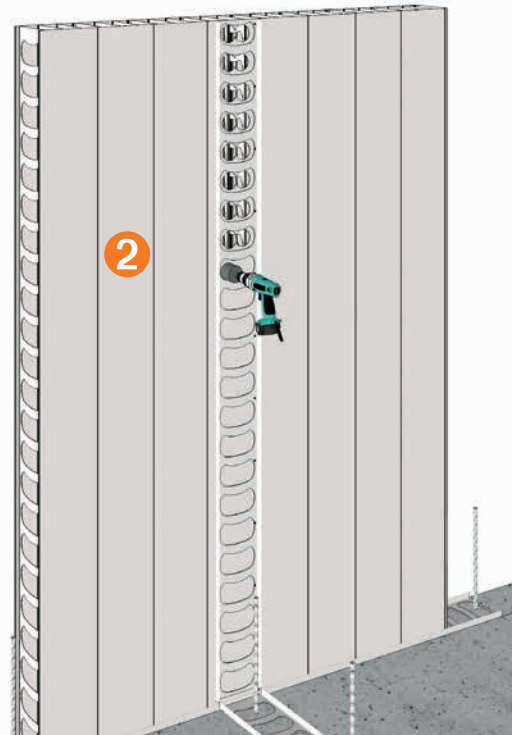

- 2 Use a hole saw to cut the rediwall® panels to allow for concrete core fill flow and steel reinforcement installation where appropriate. Refer to the Project Engineer's specifications.

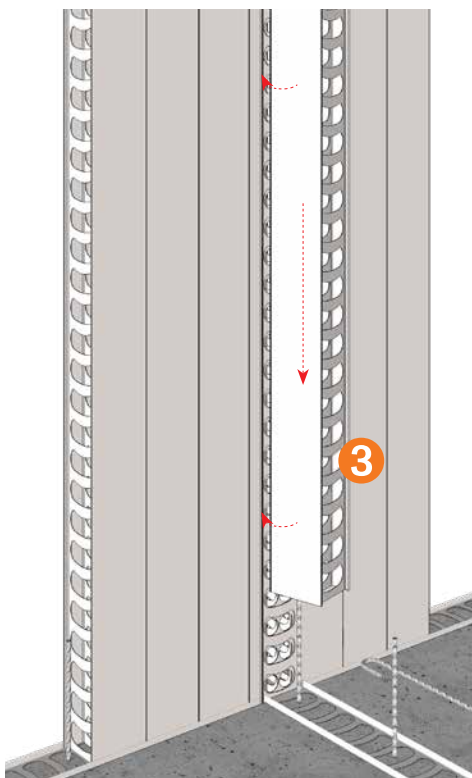

- 3 Install the first rediwall® panel to the vertical T-Joiner Track and ensure the clip edges lock securely each side of the wall.

- 4 Once a suitable number of panels have been installed, slide the hook bars through the tee wall and into the primary wall, as per engineer's details.

- 5 Ensure hook bars are aligned and slide a vertical dropper bar into the primary wall and through the hooked bars.

Bracing for T-junctions not shown for clarity. Refer to the Bracing section in this guide for details.

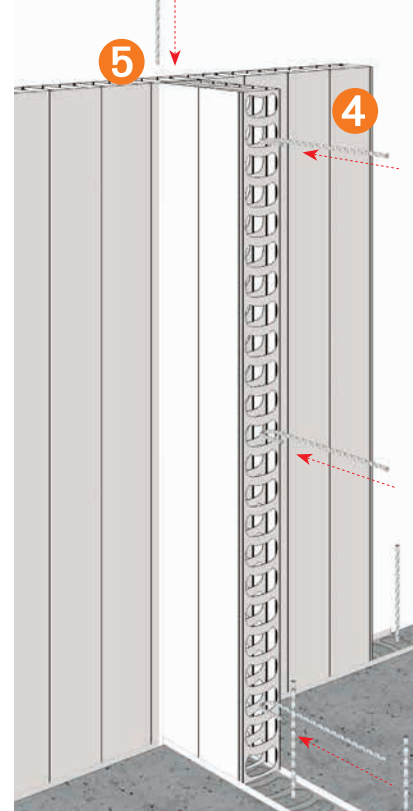

Obtuse Corner Construction

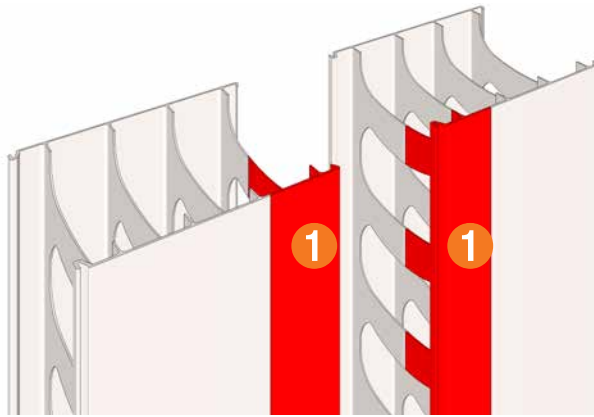

- 1 Cut the required angles from two standard panels.
- 2 Prepare floor track to accept obtuse angle panels. Mitre cut the floor track to make the required angle. Fix the floor track as per earlier instructions in this guide.
- 3 Install wall section up to the corner panels. Fix and brace.
- 4 Install the two cut panel pieces and screw fix to bottom track.

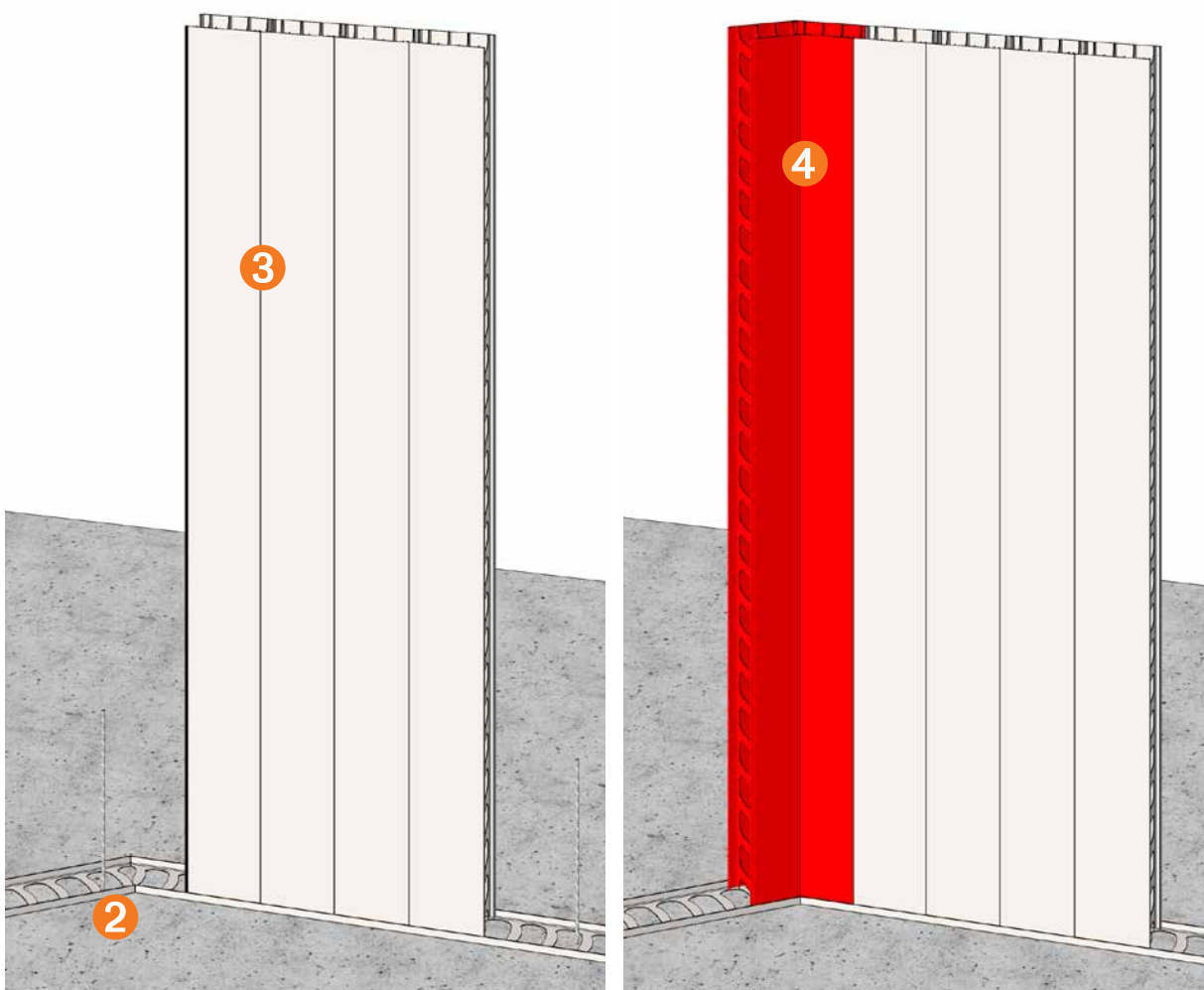

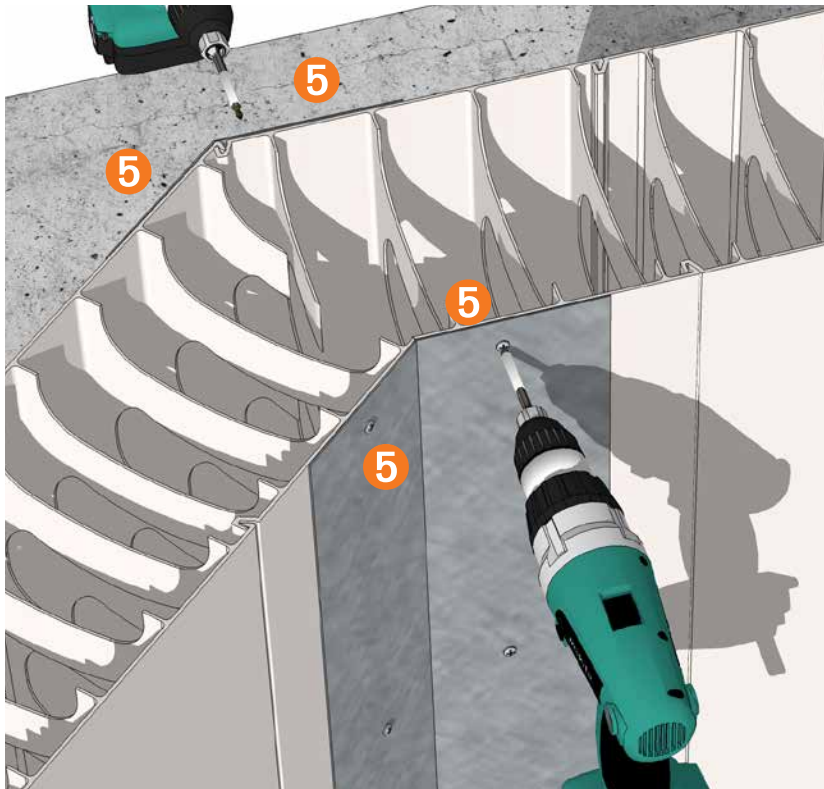

5 Screw fix appropriate galvanised steel angle squints at maximum 150mm centres to both sides of the internal and external corner junctions.

6 Continue with standard wall installation and wall bracing.

NOTE: Additional treatment may be required for a waterproof solution. Refer to the Project Engineer for details. Galvanised squints angles are available for 45° corners only.

7 For angles other than 45° the corner joint must be fully braced with PLY and LVL timber.

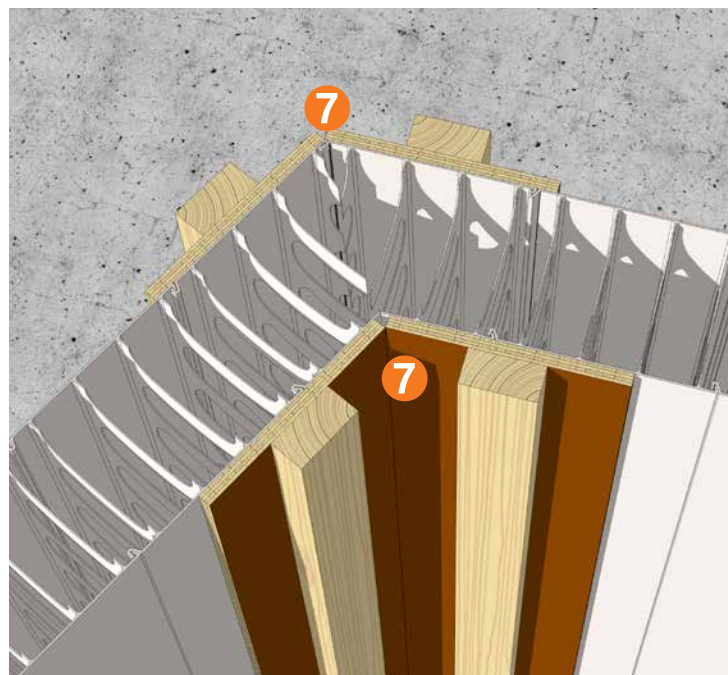
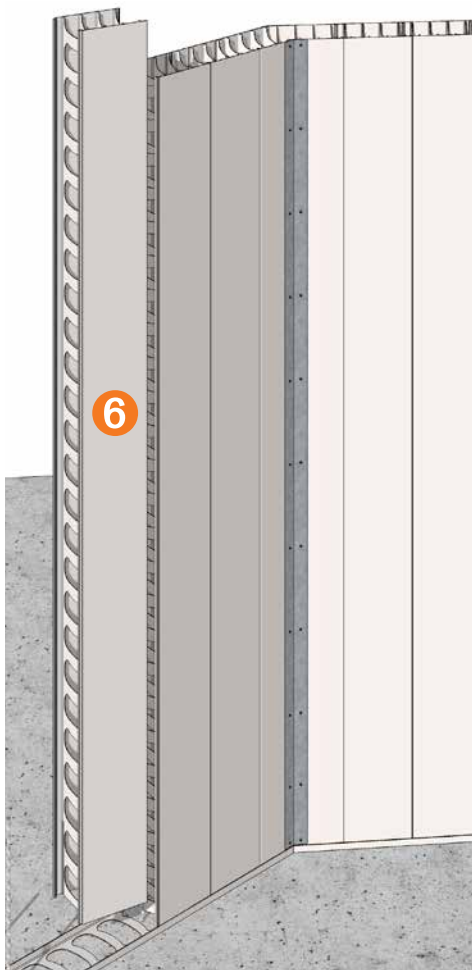

H Joiner Installation

Joining Walls with an H-Joiner

During the course of a rediwall® installation, it is likely that you will be required to join two male or female wall profiles or cut panels or will need to close a small gap in the wall panels.

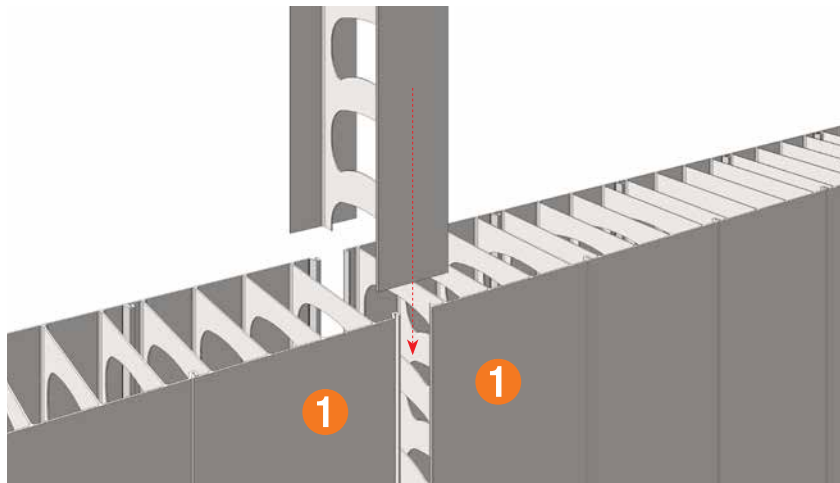

1 Align the panel ends correctly and ensure the gap is suitable for the use of an H joiner.

2 Run a bead of silicone down the inside of all four flanges of the H-Joiner. This will help seal and hold the H-Joiner in place.

3 Screw fix each H-Joiner flange with screws, at 150mm centres. Repeat on both sides of the wall.

4 Brace as per a standard wall section.

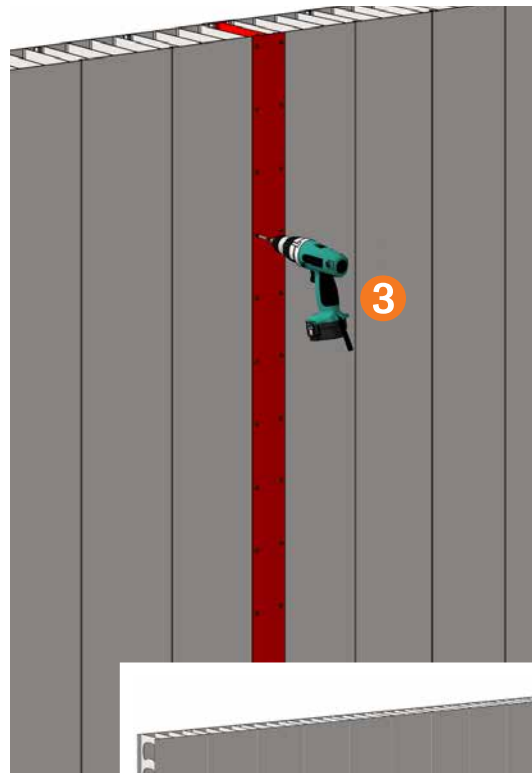
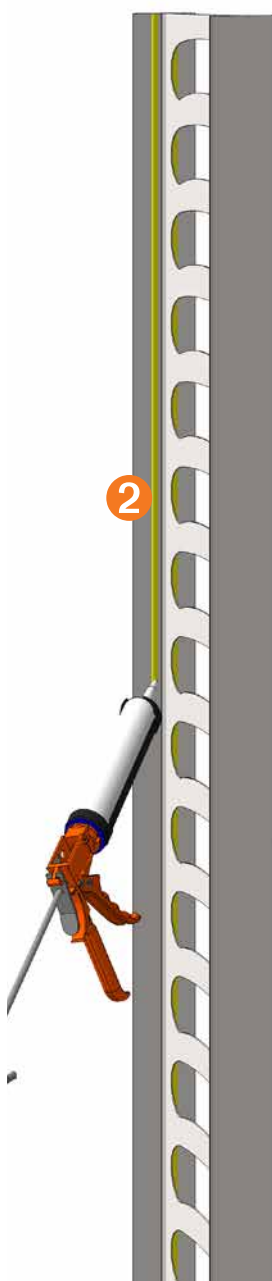

H-Joiner Installation (Limited Site Access)

Joining Walls with One Side Access

When site access is limited and an H-Joiner is required, pre-assembly of the wall section to be install may be required.

1 Install the H-Joiner and the adjacent panels. Cut the panels if required to ensure the wall sections fit together. Allow an overlap of the H-Joiner and the panel for screw fixing. Mark the panel fixing locations

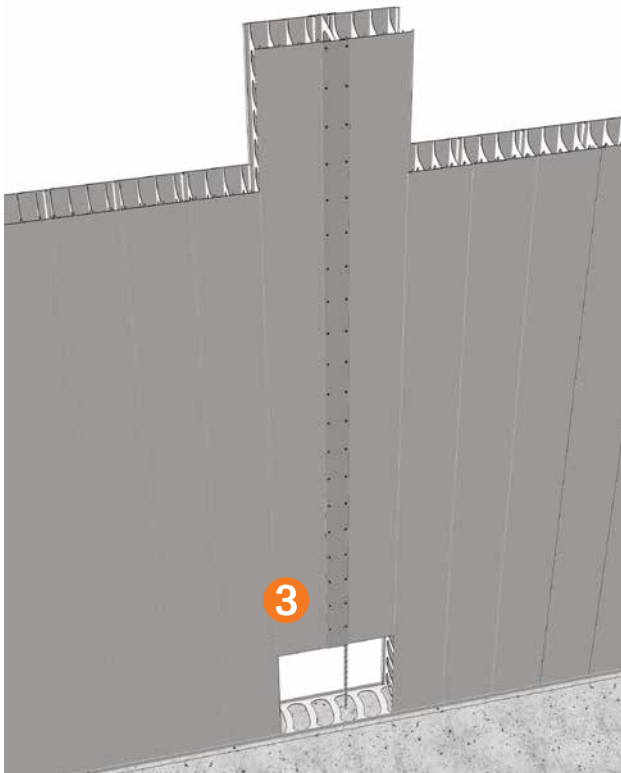
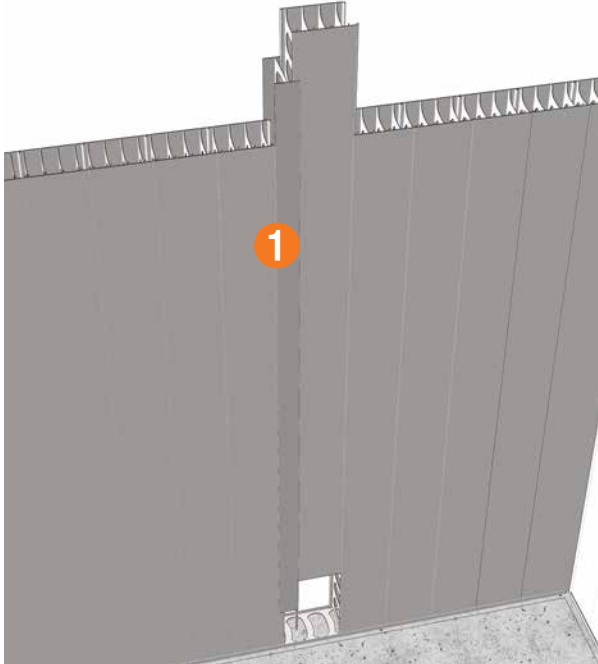

and remove the panels.

2 Apply sealant to the H-Joiner then assemble to the adjacent panels and screw fix both sides at 150mm centres. (See previous page for details).

3 Slide the panel assembly down into place and fix as per the standard method.

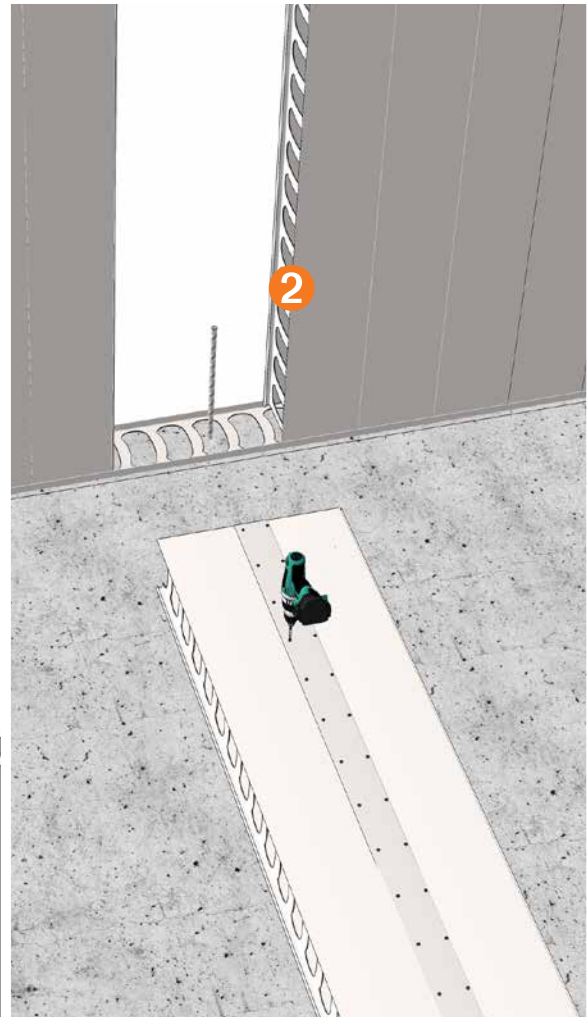

Accessory Extensions

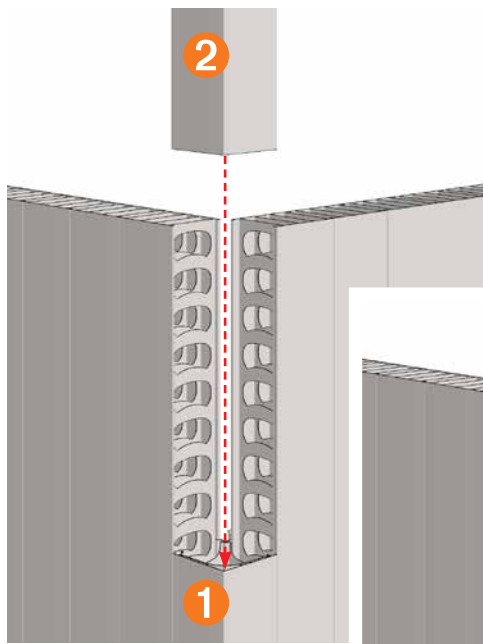

Corner Assembly

For wall heights greater than 3.6m, butt jointing of components such as corner assemblies and H-Joiners may be required. When butt jointing, ensure the joint occurs as high as possible, i.e. at 3.6m. If a joint occurs below the water table, additional treatment may be required. Consult the Project Engineer for waterproofing details.

- 1** Install the first corner assembly to a height of 3.6m.
- 2** Trim the additional corner assembly to the required height and slide into place. Fix as per standard corner details.

Note: Care should be taken when cutting to ensure the holes align for reinforcement placement.

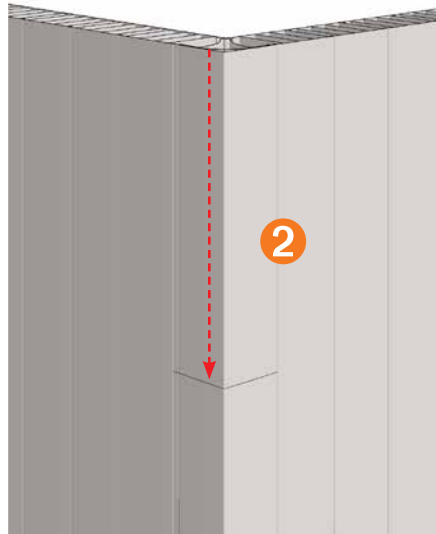

H-Joiner

- 1** Install the first H-Joiner to a height of 3.6m as per the standard installation details.
- 2** Trim the additional H-joiner to the required height and slide into place. Screw fix as per the standard installation method.

Note: Care should be taken when cutting to ensure the holes align for reinforcement placement.

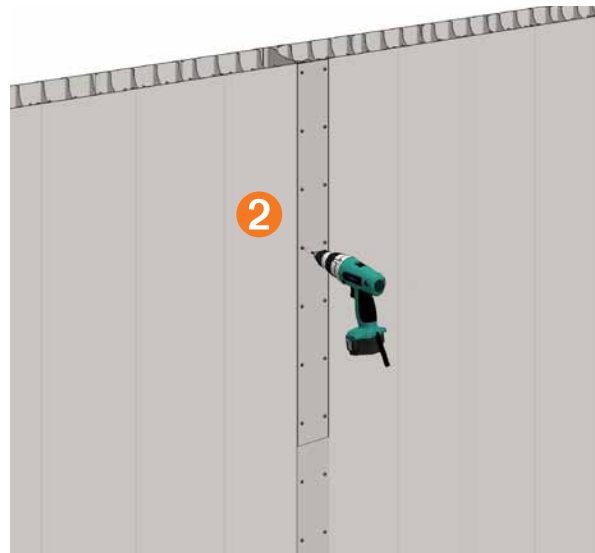
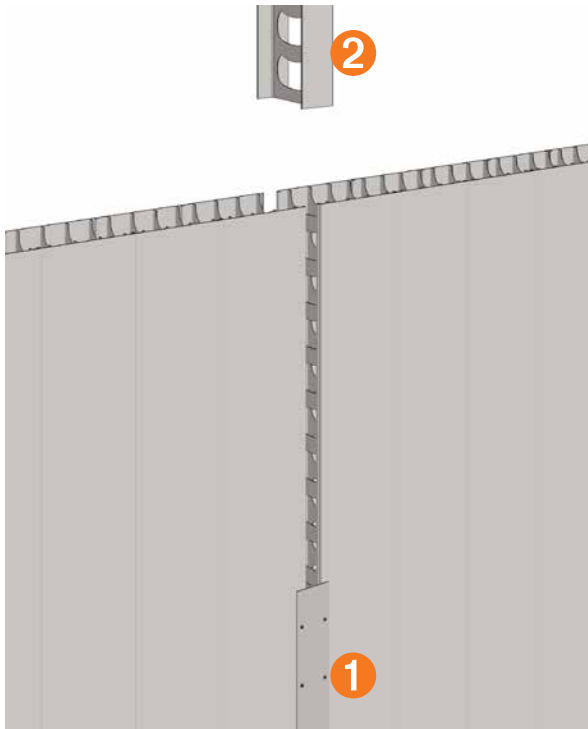

End Cap Installation



PVC End Cap

1 Wall ends or openings can be capped using the rediwall® PVC end cap. Trim the end cap to the required length and slide it onto the wall end being capped.

2 Screw fix each side with screws, at 150mm centres.

WARNING: End caps are to be braced for the full height. Refer to "Bracing End Caps" for details.

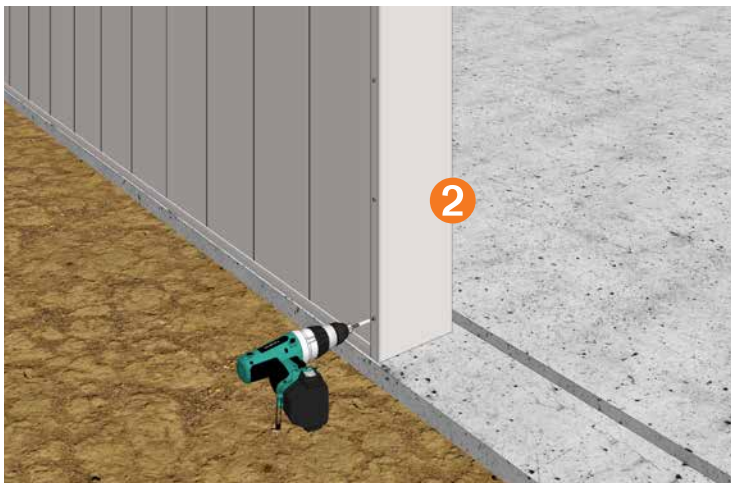

Fibre Cement Strip

Alternatively, 9mm thick fibre cement strip can be used in lieu of the PVC end cap. Fibre cement strips are available from AFS.

3 A female/female joiner can be used to convert one panel end to female. This will allow the fibre cement strip to be held securely.

4 Cut the fibre cement to length and slide into place, at the end of the panels, as shown.

WARNING: The wall end must be braced for the full height.

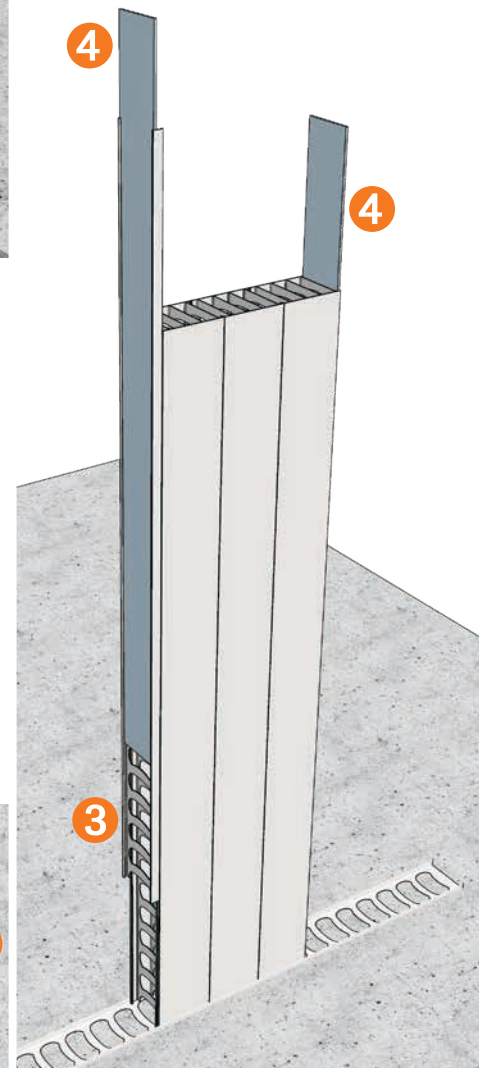

RW256S Blade Wall

Blade Walls

1 When installing an RW256S blade wall, a floor track, 50x50mm angle or other is used. Fix the base to the slab at 200mm maximum centres. Place the first RW256S panel at the end of the floor track and screw fix to the track.

2 Slide additional panels together until the blade wall is complete. Screw fix all panels to the floor track at the panel joins. Any reinforcement bars required should be slid into place before installing the end caps.

3 Finish the end of the blade wall with the RW256S End Cap, Quick Cap or Fibre Cement

Strip as shown. An RW256S female/female joiner is required to mate a Quick Cap to the male end of the panel profile.

WARNING: End caps are to be braced for the full height.

Note: A timber kicker can also be used for alignment and containment of the base of the blade wall.

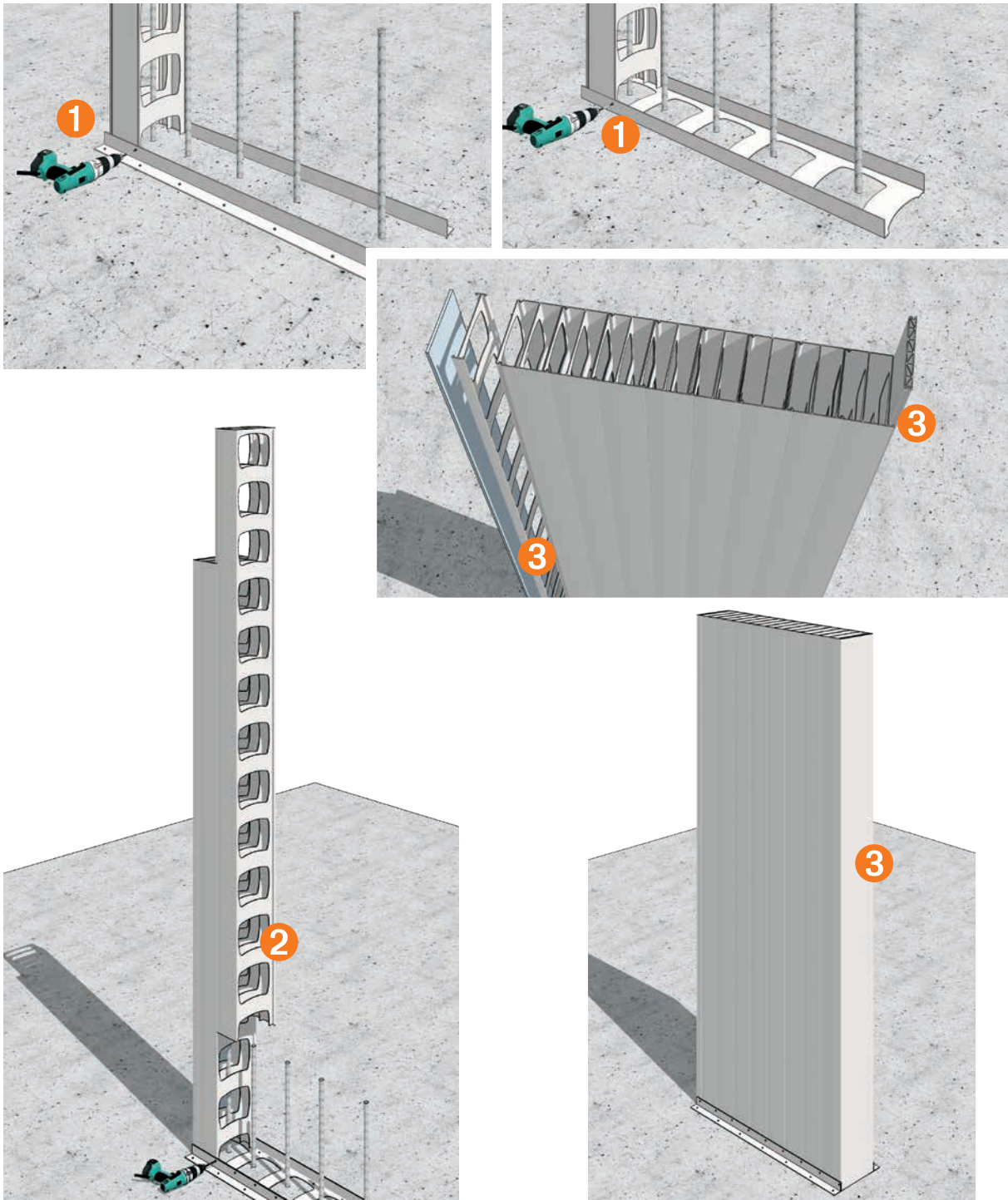

Rediwall® Edge Form

Rediwall® Edge Form

1 Once the wall has been installed and the formwork deck is in place, use a grinder to cut out the top edge section of the rediwall® panels.

2 Additional bracing is required along the edge form section. See edge form bracing in this manual.

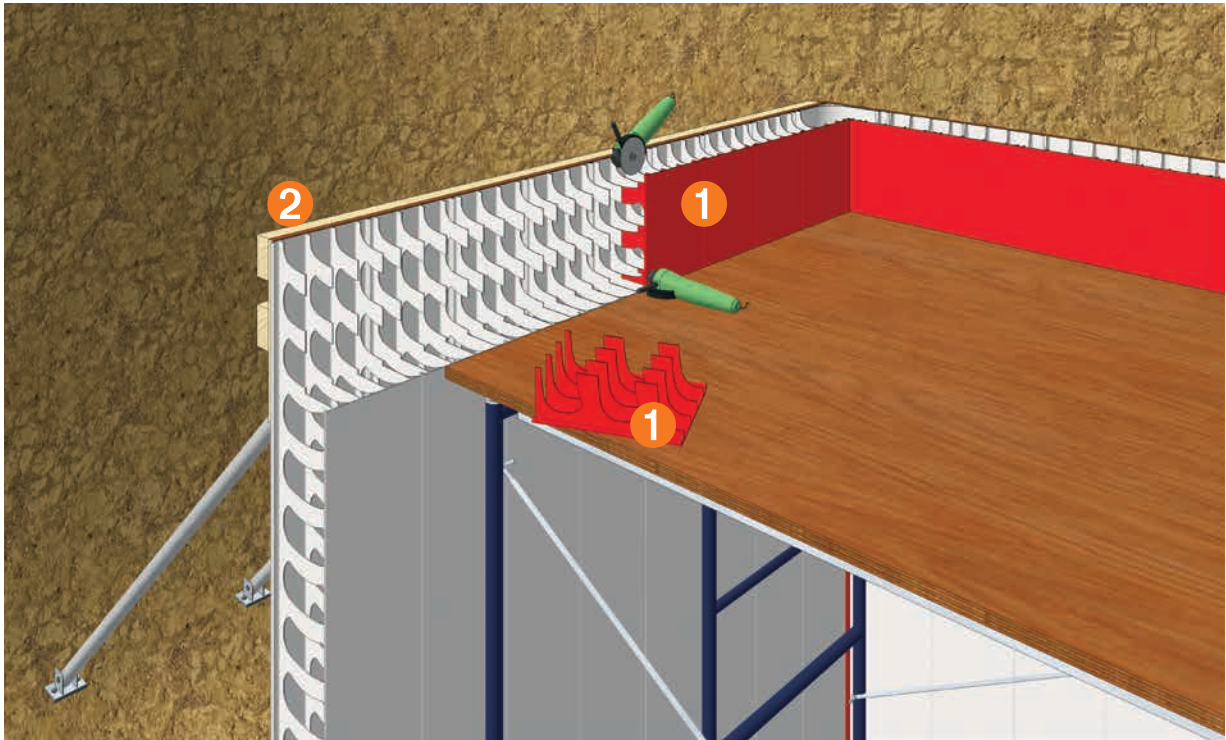

Rediwall® J-Track Installation

J-Track

When continuing a wall to another storey, J-Tracks are used as floor track at the junction of the upper wall and suspended slab (e.g. stair shafts, lift shafts and external walls). For external walls, waterproofing details for this junction are to be determined by the Project Engineer.

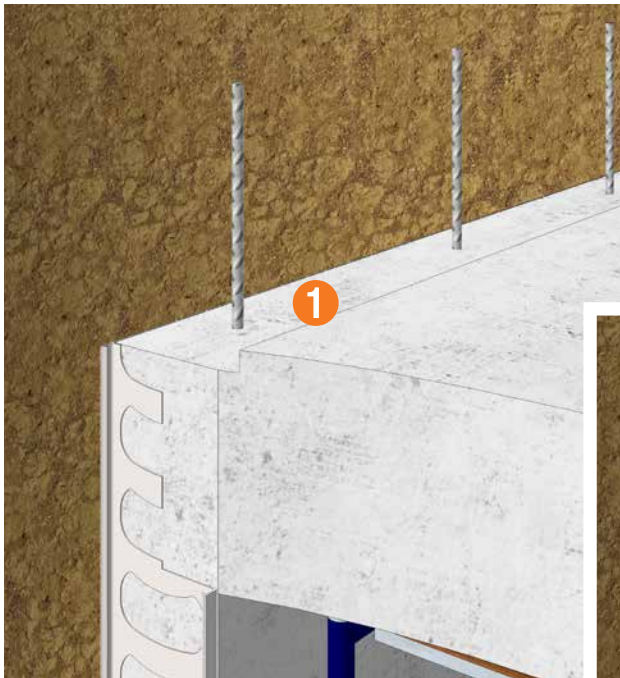

- 1 Ensure that the suspended slab surface is free from debris and the level is checked and corrected as required. The Project Engineer should be consulted in relation to correct starter bar placement.

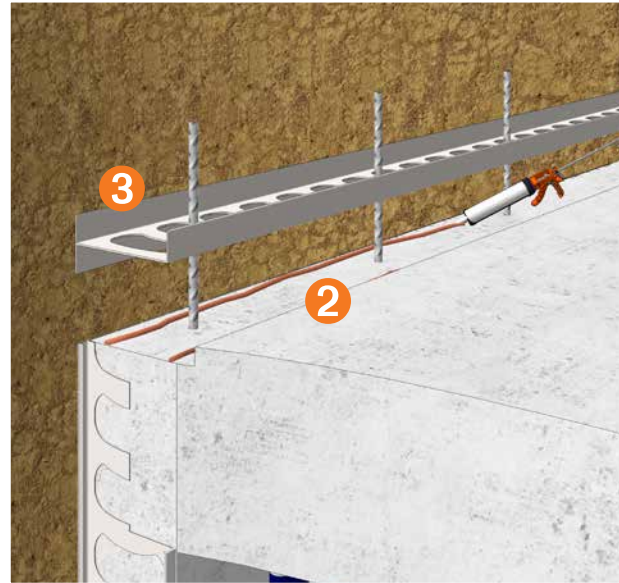

- 2 Two beads of polyurethane sealant or as per waterproofer's details, must be applied in accordance with the manufacturer's instructions under the rediwall® floor track (one on each side of the track) on all external walls.

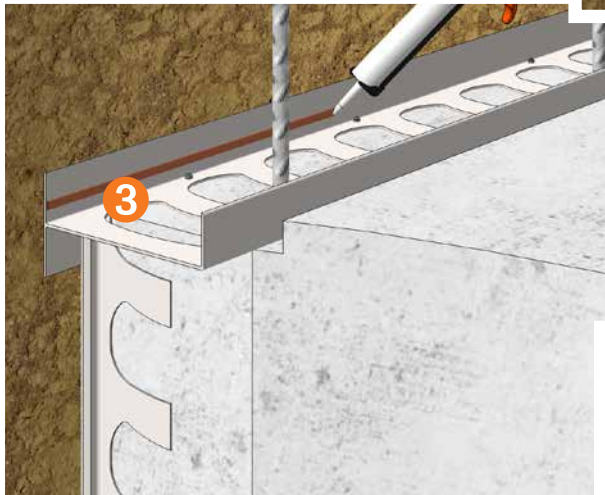

- 3 Rediwall® J Track is then placed in the required location and fixed to the concrete slab using a masonry fixing gun or drill and anchor masonry fixing system. Fix with fasteners each side of the track at 500mm centres for walls up to 5m height, or at 250mm maximum centres for walls over 5m height.
- 4 Start the new wall as per the standard wall construction method in this manual. Ensure any bracing is adequate for multilevel construction, refer to the Project Engineer for details.



Window Openings

Sills and Lintels

Rediwall® PVC End Cap is used for closing off at the underside of lintels and at the sides of openings. Lintels can be built into the wall or cut out of the installed panels.

WARNING

It is imperative that all lintels and openings are provided with sufficient support to withstand the weight of concrete prior to core filling. Refer to the Bracing section on for details.

- 1** Install sill panels as per site plan. AFS recommends installing 2 or 3 additional panels on the side of the sill as per normal panel installation.
- 2** Install End Cap to the sides of the opening to the required height and screw fix at 150mm centres each side of the wall.

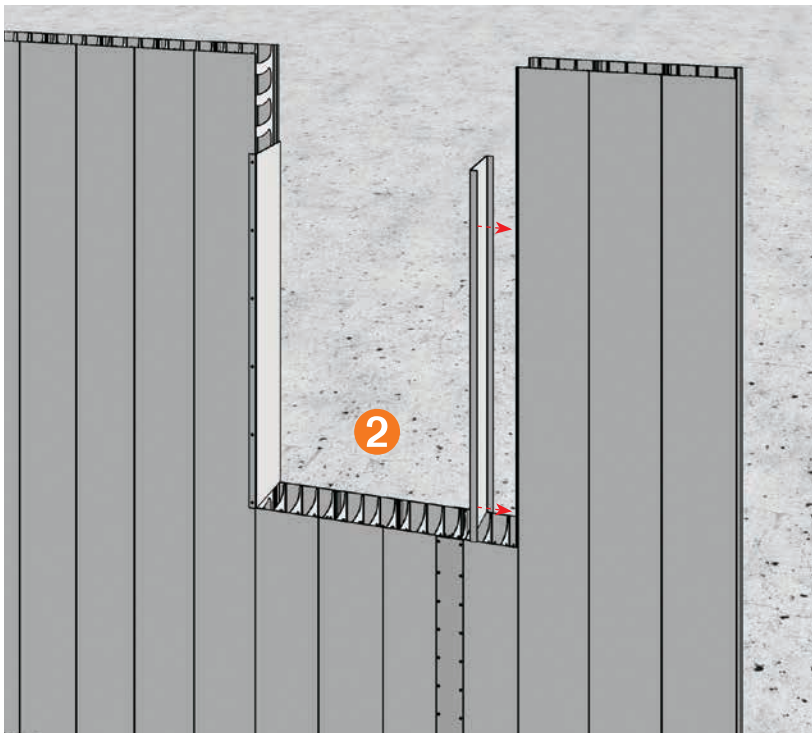
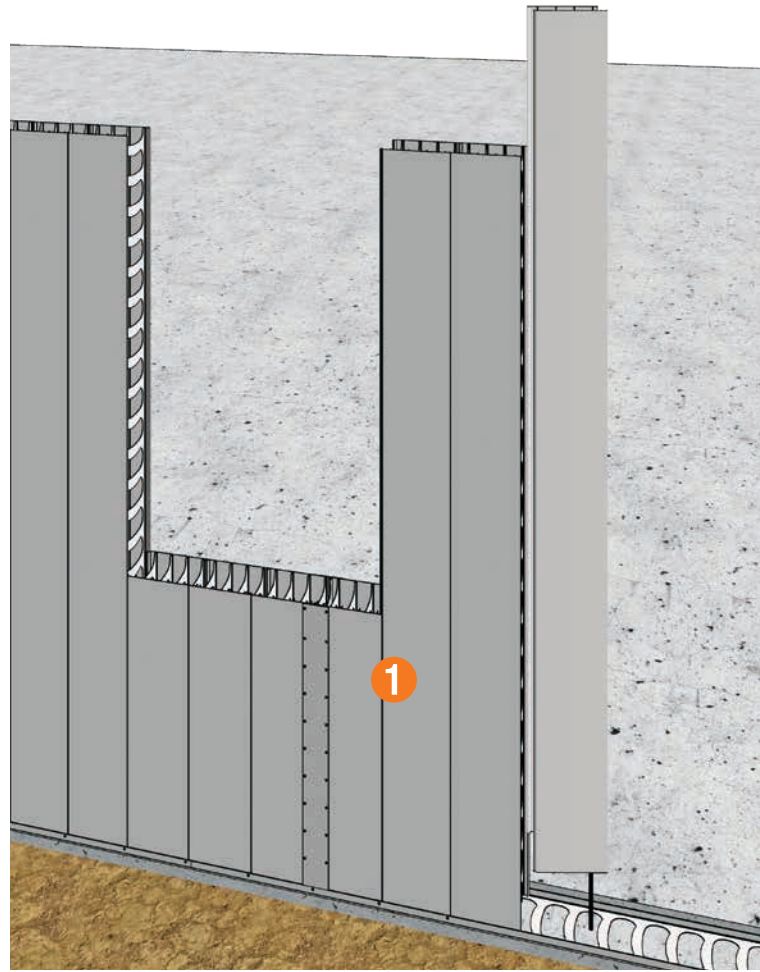

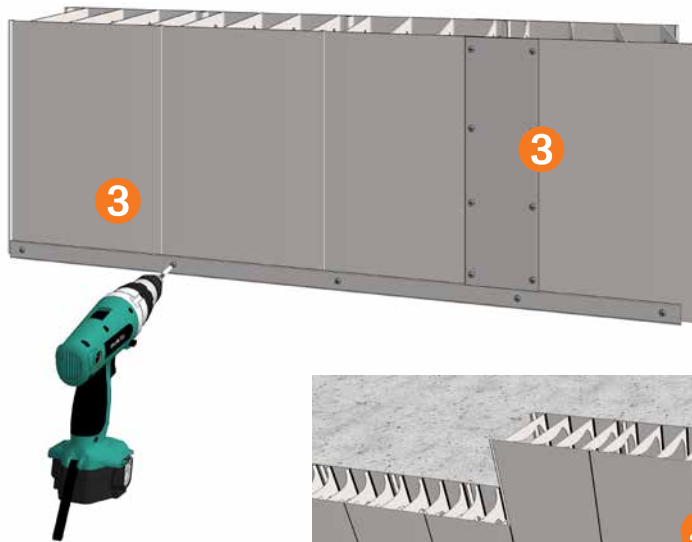

- 3** Assemble the lintel section separately. Fit End Cap to the bottom of the lintel panels and screw fix on each side of the wall at 150mm centres. Cut End Cap to allow for interlocking with adjoining panels on both ends. H-Joiners may be inserted to make up the correct distance and screw fixed at 150mm centres to both adjoining panels.

- 4** Slide the lintel assembly into position and screw fix in place at each end of the lintel and on both sides of the wall at 150mm centres.

- 5** Trim the sill panels to create a 5° fall to the outside face of the wall.

- 6** After core filling, remove end caps as per architectural details.

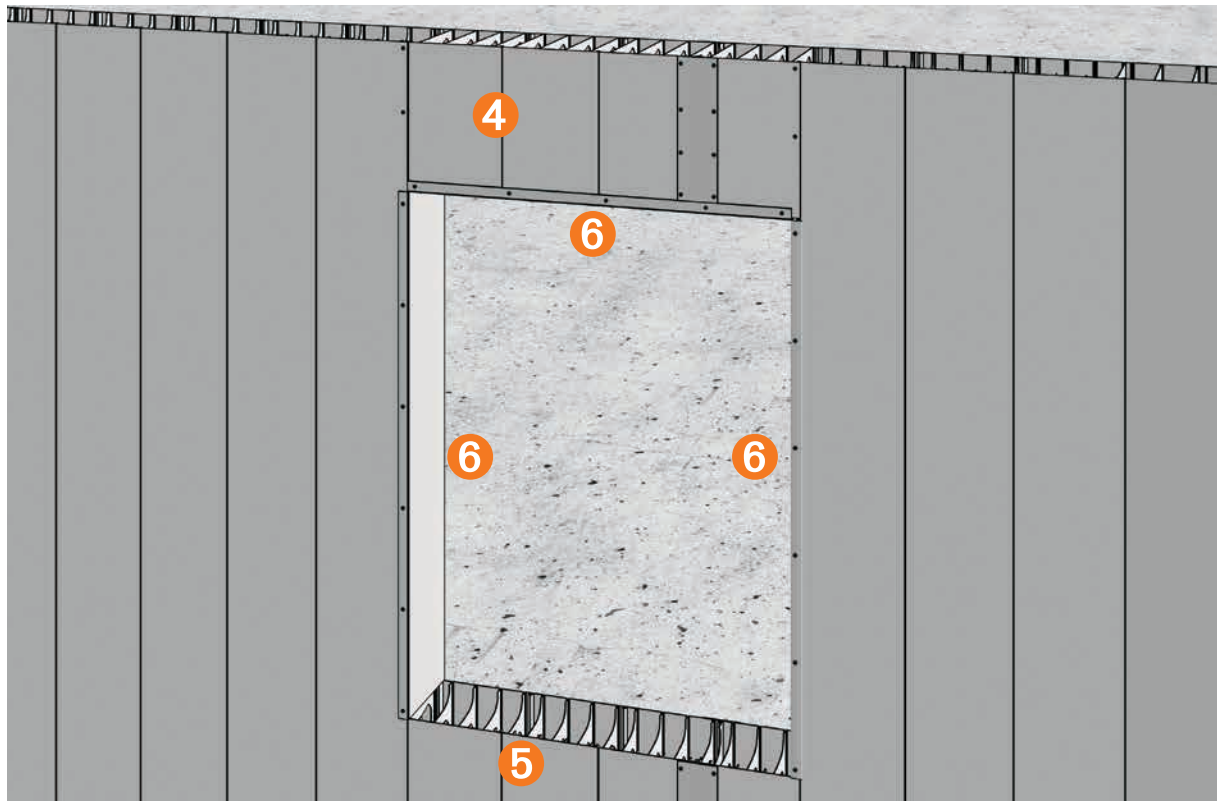
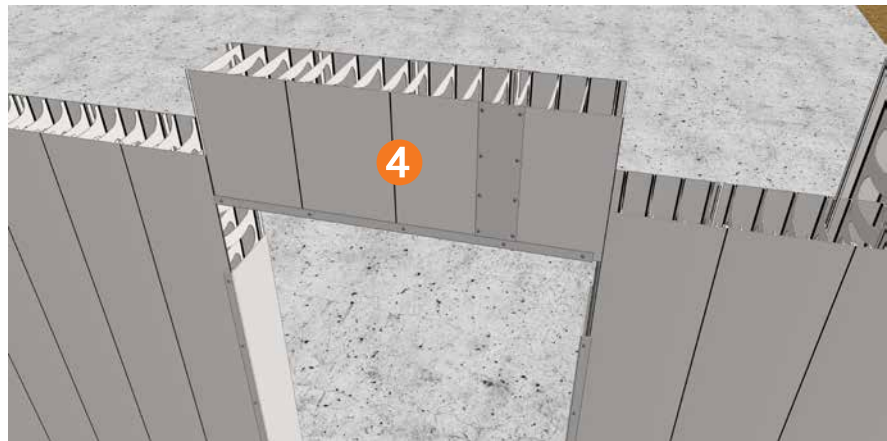

Doorway & Lintel Installation

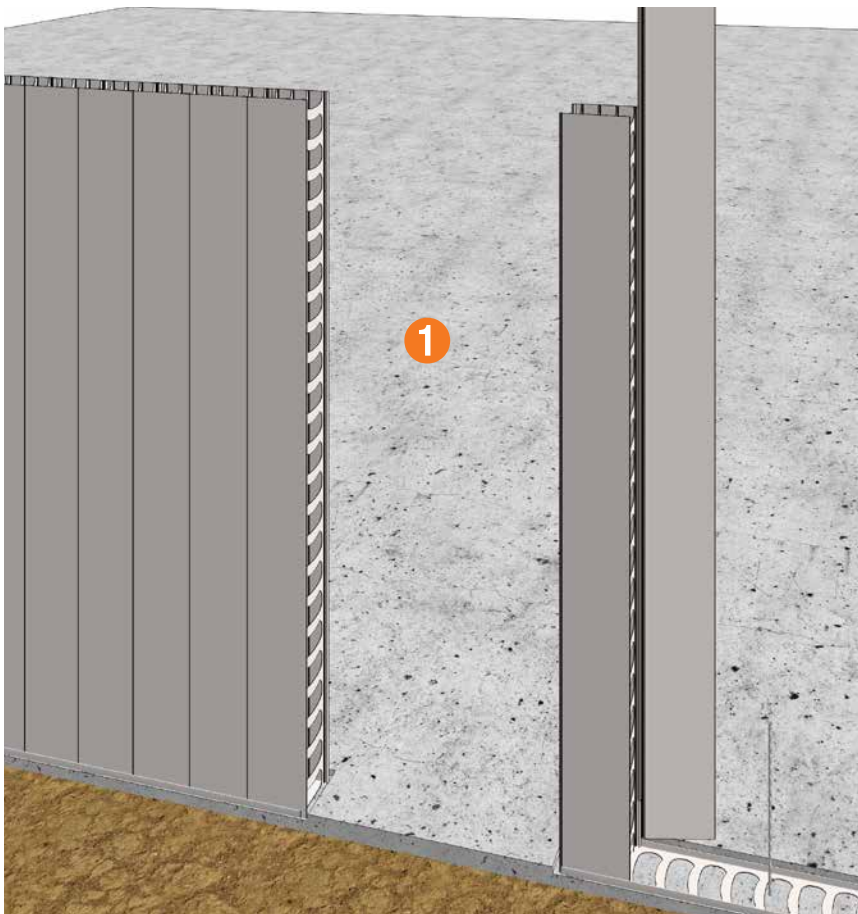

Doorway with PVC Capping

Rediwall® PVC end cap is used for closing off at the base of lintels and at the sides of openings. Doorways can be built into the wall or cut out of the installed panels.

It is imperative that all lintels and openings are provided with sufficient support to withstand the weight of concrete prior to core filling.

WARNING: All openings are to be braced. Refer to the bracing section for details.

1 Install wall panels as per site plan. AFS recommends installing at least three panels on each side of the opening as per normal panel installation.

2 Install End Cap to the sides of the opening to the required height and screw fix to both sides of the wall at 150mm centres.

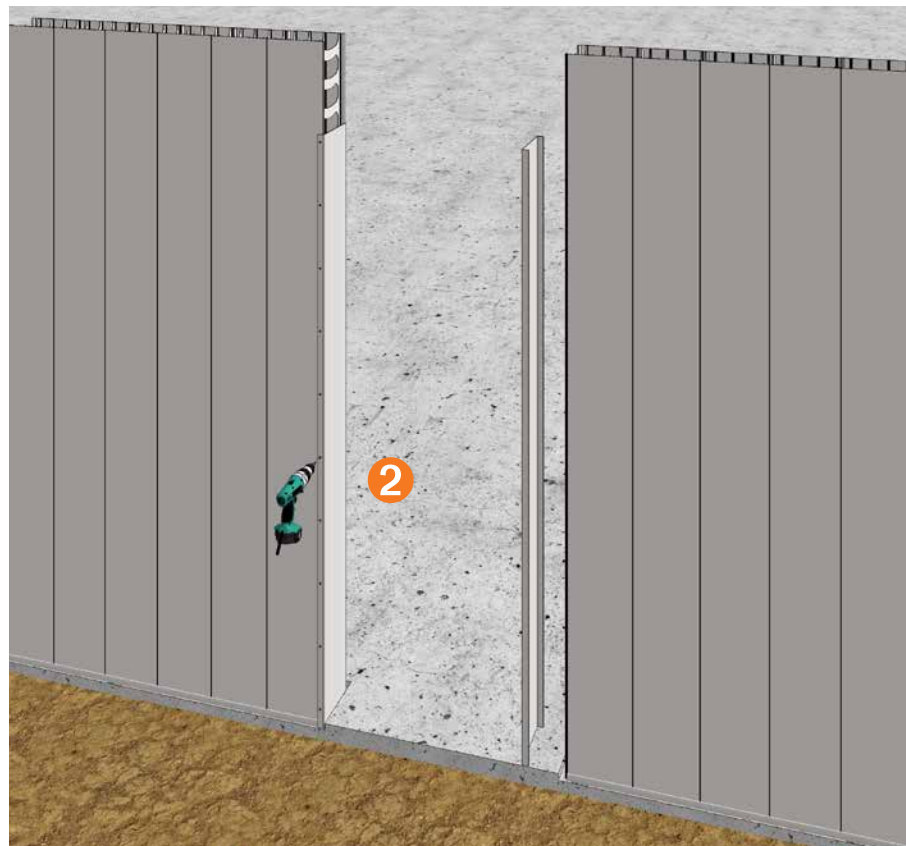

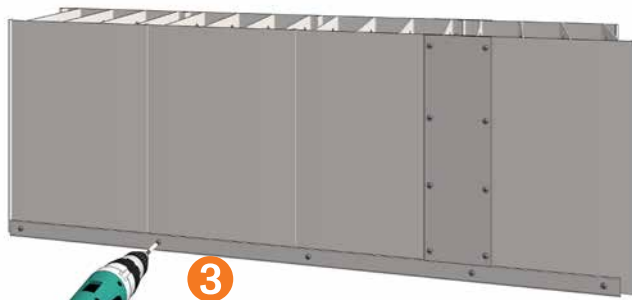

- 3** Assemble the lintel section separately. Fit End Cap to the bottom of the lintel panels and screw fix on each side of the wall at 150mm centres. Cut End Cap to allow for interlocking with adjoining panels on both ends. H-Joiners may be inserted to make up the correct distance and screw fixed at 150mm centres to both adjoining panels.

- 4** Slide the lintel assembly into position and screw fix in place on both sides of the wall and at each end of the lintel at 150mm centres.

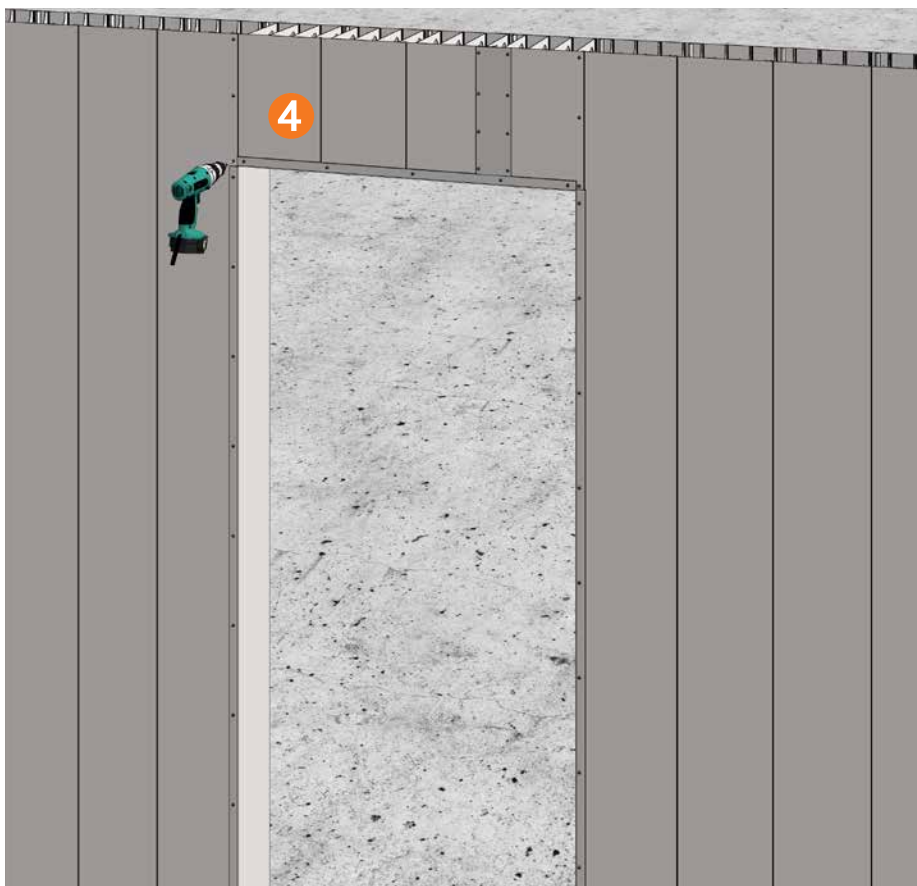
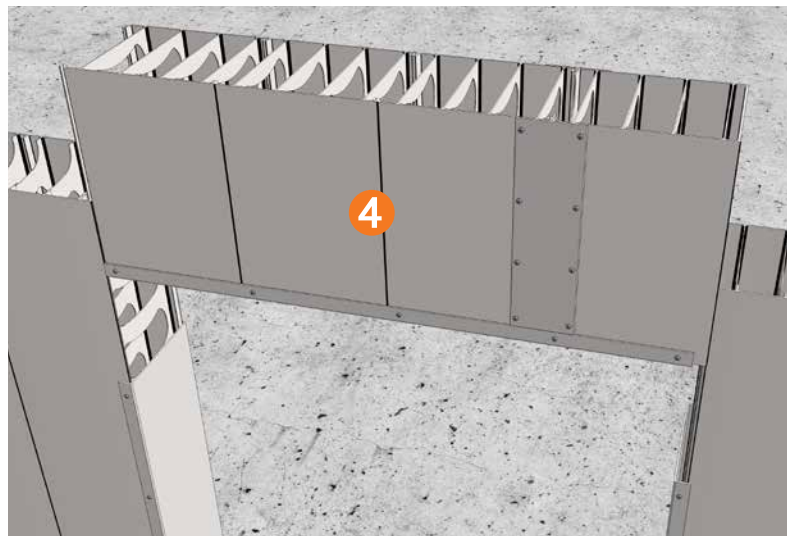

Doorway with Steel Frame (Internal Fit Jamb)

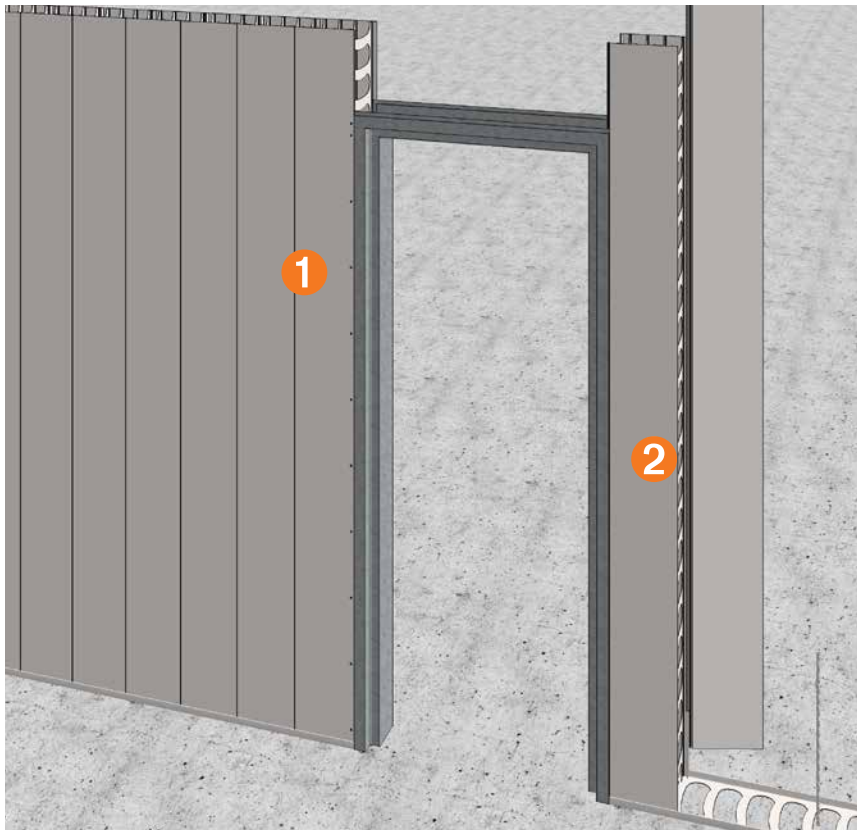

WARNING: All openings are to be braced. Refer to the Bracing section on for details.

1 Where a metal door frame is to be fitted, the frame is slid into position with the door jamb member inside the rediwall® panel flange. Removal of some of the PVC clip profile may be required to ensure a proper fit. Screw fix at 150mm centres on both sides of the wall.

2 The next full size rediwall® panel is then placed and engaged in the door jamb member. Screw fix at 150mm centres on both sides of the wall.

3 Lintel sections are then slid into place above the door frame. Fix in place on both sides of the wall and at each end of the lintel using screws at 150mm centres. Removal

or slitting of the panel webs may be required to ensure correct fit.

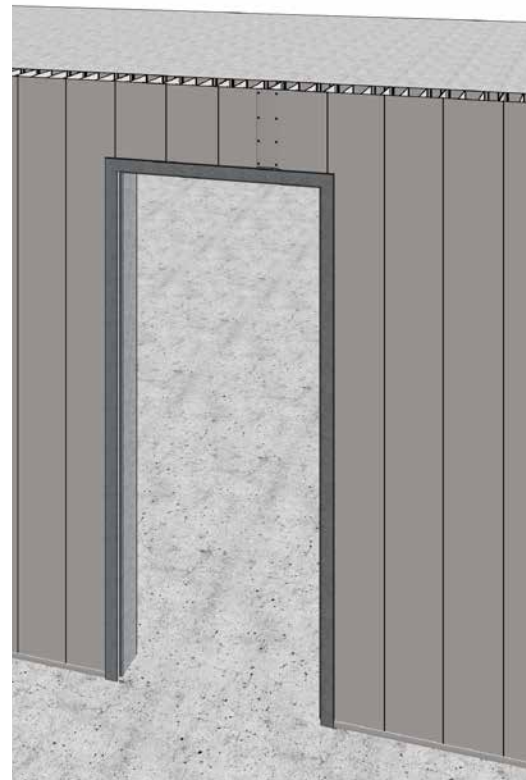
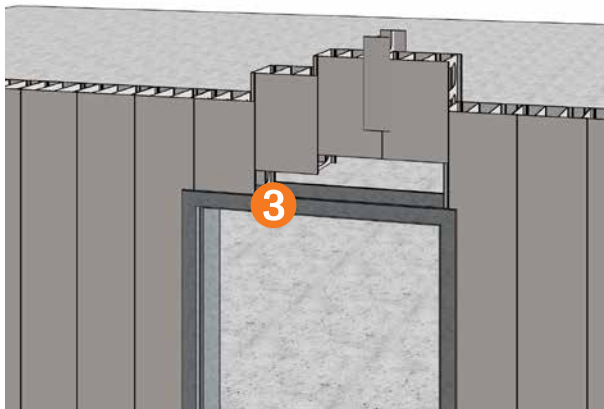

Alternative Procedures

The rediwall® panels either side of the doorway are fixed into position, plumbed and braced (ensuring the opening between them is accurate for the frame). The frame can then be lowered between the panels. The lintel panel is pre-assembled on-site and lowered into position, engaging into the panels on both ends and dropping down into the head of the door frame.

Retro-fitted Doors

Where a doorway is to be retro-fitted with a door frame, the opening is constructed, capped and braced as for a window opening but without any sill panel.

Wide Radius Curved Wall Installation

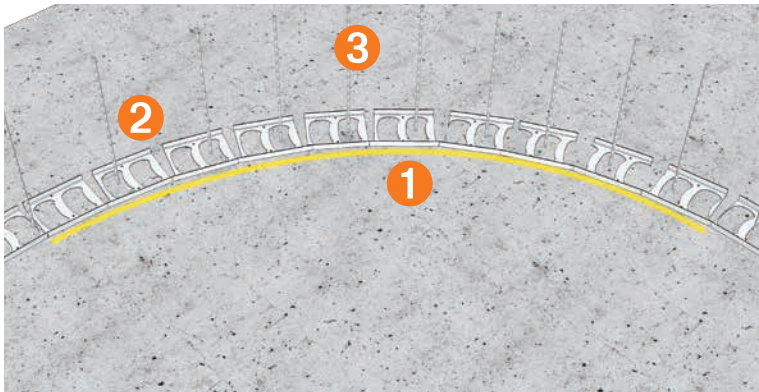

Curved walls

- 1 Mark inner radius of the curved wall on the slab or footing.
- 2 Slit the floor track on one side only (the convex side of the curve) to allow the floor track to be bent to the shape of the curve.
- 3 Lower the floor track over the starter bars and place into position to the radius required. Fix each track section to the concrete footing or slab using a masonry fixing gun or drill and anchor masonry fixing system each side of the track.

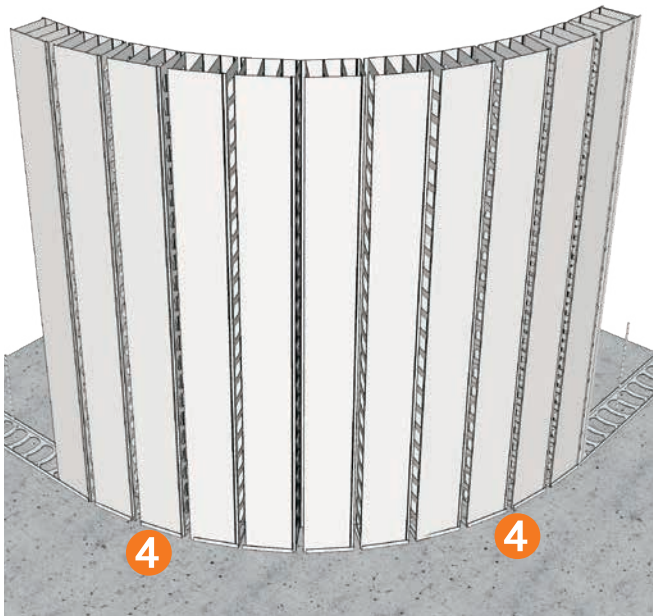

- 4 Begin by installing standard panels into the floor track and screw fix both sides of the bottom of the panel to the floor track at 150mm centres.

- 5 Using H-Joiners as spacers, slide them in between the joins and screw fix them both sides to each panel at 150mm centres.

Alternative Procedures

For walls with a large radius (radius greater than 5m), the panels may be installed to follow the floor track curve without panel modification or any additional components.

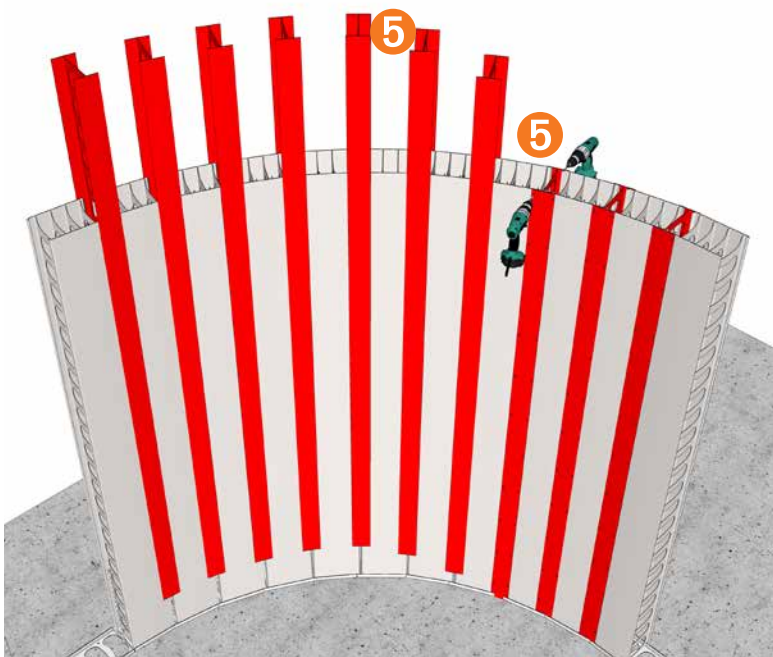

After installing the curved floor track, continue the wall by erecting panels in place allowing a small direction change in each wall segment. Screw fix panels to the floor track as erection proceeds.

WARNING: Refer to the Bracing section for details.

Additional treatment may be required for a waterproof solution refer to the project engineers for details.

Curved Wall Reinforcement Bar Installation

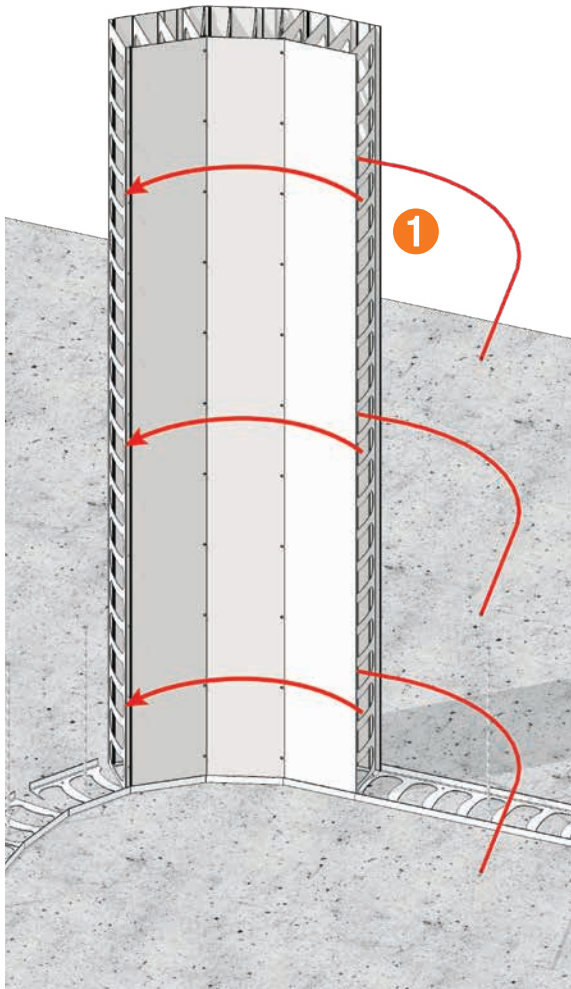

Installing Pre-curved Bars

If reinforcing bar is to be installed it can be pre-ordered bent to the required radius.

- 1** For wide radius curves – pre-bent reinforcing can be installed from one end of the wall as the panels are being installed.
- 2** Install 1 or 2 more panels on the curve and feed the pre-bent reinforcing into the last installed panel. Continue this procedure until the curve is complete.

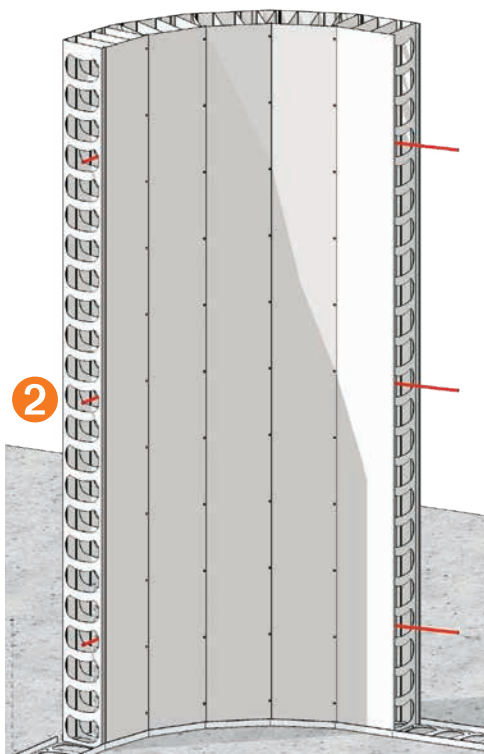
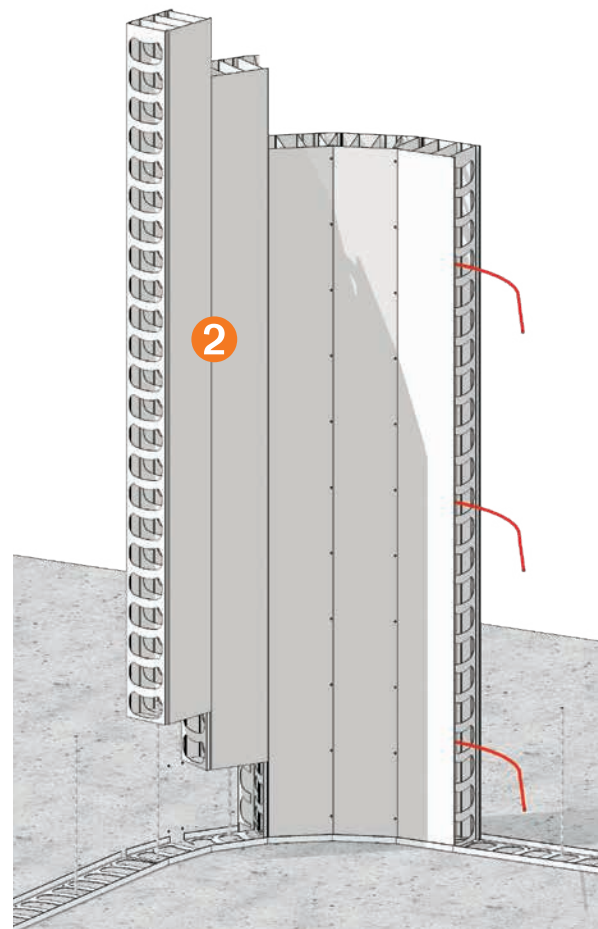

Alternative Installation

On long curves and tight radius curves where it not possible to insert one long length of reinforcing bar, the bar can be installed in shorter lengths as the panels are being installed.

At junctions with straight walls and where more than one length of reinforcing is being used in curved wall sections, it is important to ensure appropriate lapping of the bars is being achieved, in accordance with Project Engineer's specifications.

Stairway Landing Construction

Stairs

WARNING: Where rediwall® panels are to be engaged with a landing or stairs, care is to be taken when creating openings in the rediwall® panel face to ensure that the web inside is not damaged causing the panels to be weakened.

Additional bracing support should be provided as per details in the Bracing section of this guide

1 Engagement of the wall and adjoining structure can be achieved by cutting holes in the rediwall® face to install reinforcing bars. Use a hole saw as per Structural Engineer's details (100mm maximum diameter).

2 Insert the required reinforcement steel as per the Structural Engineer's details.

NOTE: Formwork and bracing for stairs and landings is the responsibility of the site builder and engineer. Additional bracing may be required where suspended slab is tied in.



Retention Tank Construction & Tanking

All waterproofing details are to be completed by the Project Builder and Waterproofing Contractor. When filled with concrete, rediwall® is a water resistant wall system. However specific areas requiring waterproofing details include horizontal concrete cold joints, and where water can track down along panel joints.

Any required waterproofing products must be installed strictly in accordance with the particular manufacturer's instructions.

1 Determine the line of the rediwall® panels on the slab and install PVC floor track with centre cut out to accommodate waterstop. Mechanically fix the angle to the slab at 500 – 600mm centres.

2 Install Waterstop to manufacturer's instructions, maintaining a continuous seal. Refer to the project building designer for details on Waterstop performance and installation requirements. Ensure that the water stop remains unobstructed through the rediwall® profiles and that it is not cut by the internal webs.

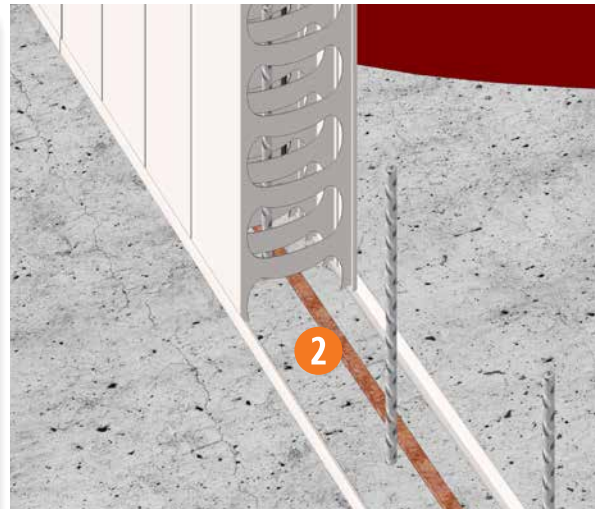

3 Install the remaining rediwall® panels as per the standard installation method. Complete the tank with the required steel reinforcing as per Engineer's details.

4 Core fill with concrete following the AFS recommended guidelines.

5 A waterproof tanking finish is required. Apply tanking (supplied by others) as per the Engineer's details.

Note: The structure must be fully braced on both faces before concrete filling. Refer to the Bracing section for details.

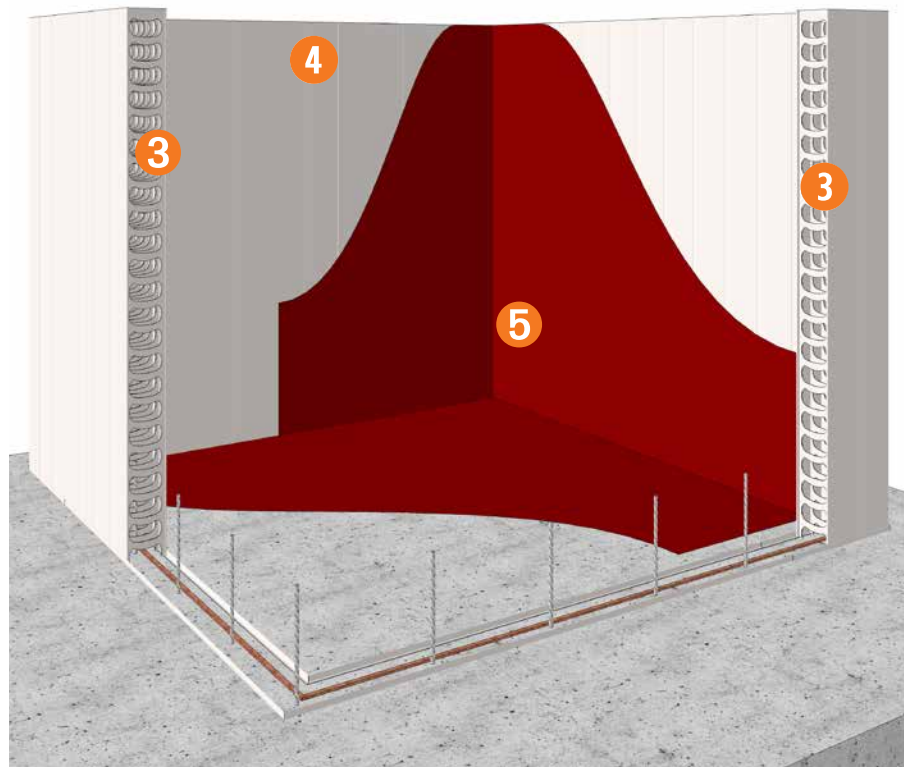

Lift Pit

All waterproofing details are to be completed by the Project Builder and Waterproofing Contractor. When filled with concrete, rediwall® is a water resistant wall system. However specific areas requiring waterproofing details include horizontal concrete cold joints, and where water can track down along panel joints. Any required waterproofing products must be installed strictly in accordance with the particular manufacturer's instructions.

1 A waterproof tanking finish is required. Apply tanking (supplied by others) as per the Engineer's details.

2 Determine the line of the rediwall® panels on the slab and install PVC floor track with centre cut out to accommodate waterstop. Mechanically fix the angle to the slab at 500 – 600mm centres.

3 Install Waterstop to manufacturer's instructions, maintaining a continuous seal. Refer to the project building designer for details on Waterstop performance and installation requirements. Ensure that the water stop remains unobstructed through the rediwall® profiles and that it is not cut by the internal webs.

4 Install the remaining rediwall® panels as per the standard installation method. Core fill with concrete following the AFS recommended guidelines.

5 Complete the waterproof tanking as required (supplied by others) as per the Engineer's details.

Note: The structure must be fully braced on both faces before concrete filling. Refer to the Bracing section for details.

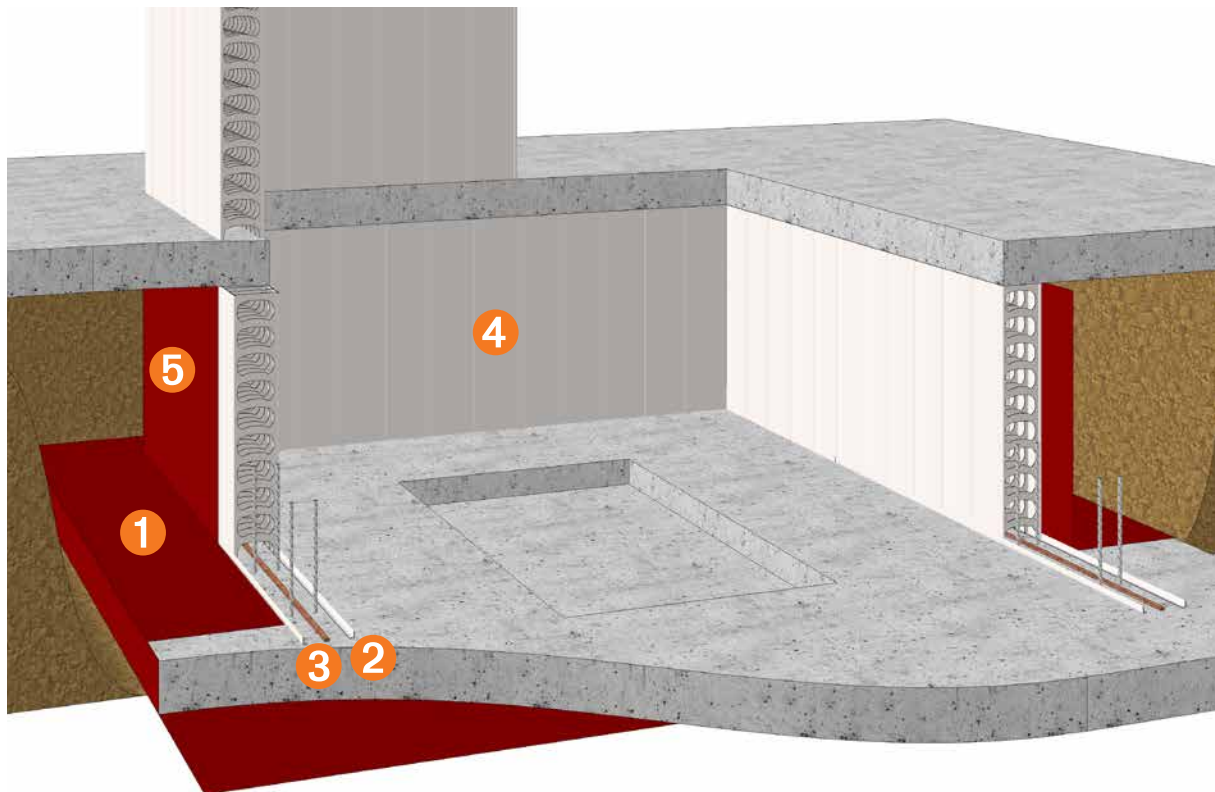

Installation of Services

Services Within Walls

Placement of electrical and data services within the afs rediwall® panel must take place between installation of wall panels and prior to concrete core filling. AFS does not recommend placement of high pressure services such as water or gas lines inside the wall panels.

Consideration should be made for the impact to acoustic performance of the wall due to service cast ins.

1 Cut a hole at the required location for the service box.

2 Insert the pre assembled conduit and service box.

3 Screw fix the service box in place using a plaster bracket or similar. A screw is to be placed through the conduit to ensure that it does not dislodge from the wall box.

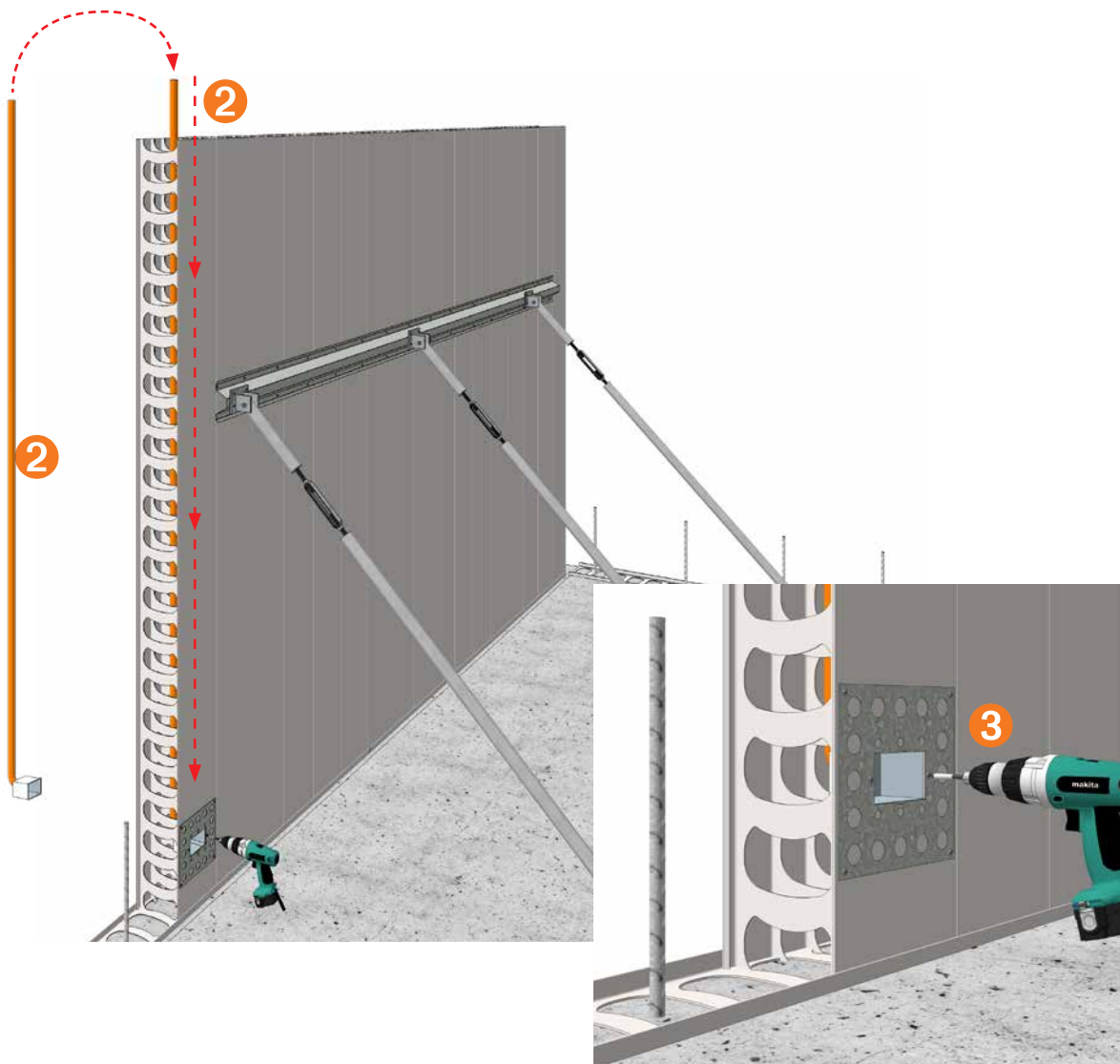
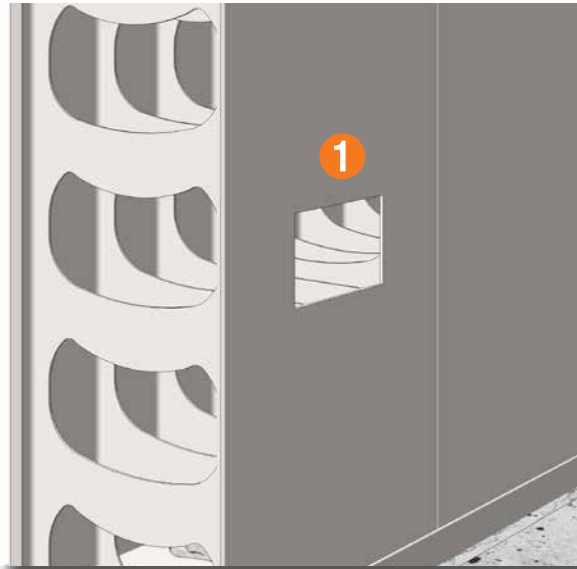

Penetrations

Non Fire Rated Service Penetrations

Penetrations for services and mechanical requirements may be cut on-site prior to core filling.

Alternatively, services penetrations may be cut/core drilled after core filling.

Refer to project specifications for details.

Rectangular Openings

- 1** Neatly cut out the required section from the assembled rediwall® panels.
- 2** Install End Cap to the sides of the opening, and screw fix at 150mm centres on each side of the wall.

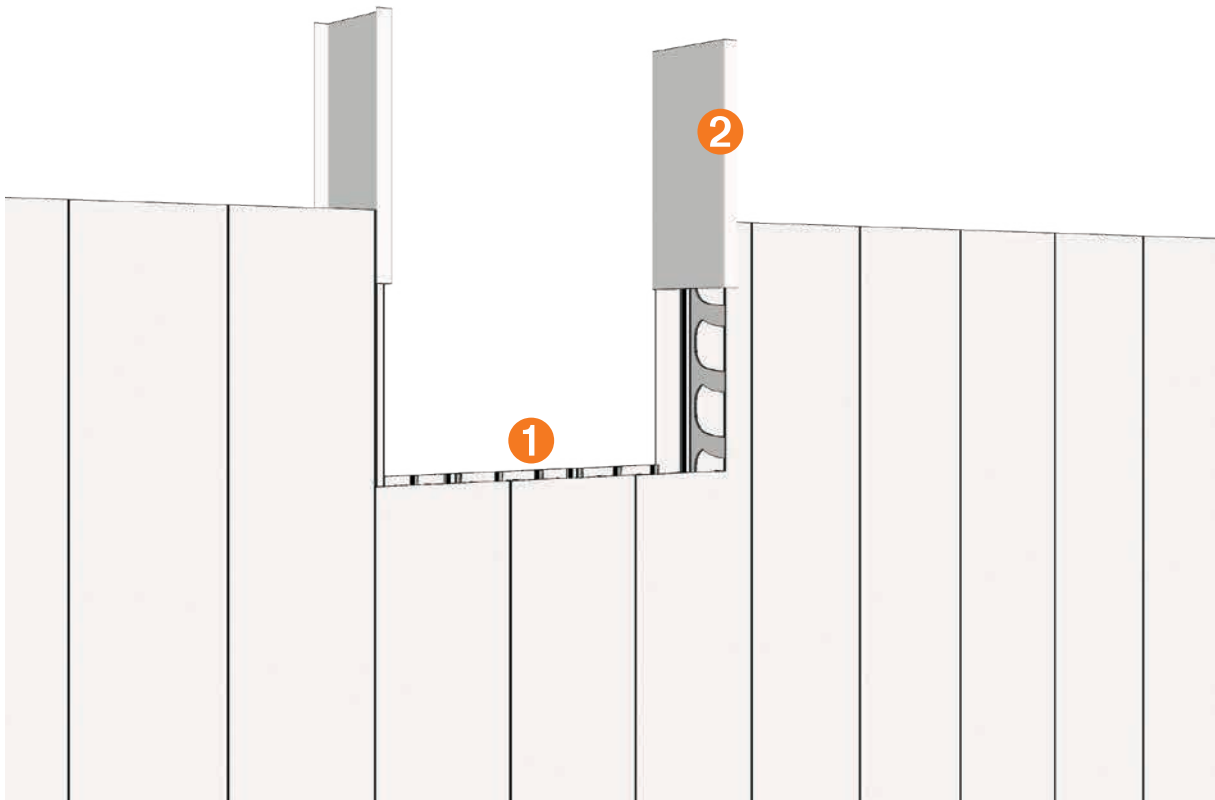

Fire Rated Penetrations

Installation of a fire collar may be required in some situations.

Refer to the fire collar manufacturer's installation guide for details.

Installation of the fire collar is done after core filling.

1 Core drill the required hole from the rediwall® panels and remove the PVC facing around the hole in accordance with the fire collar installation instructions, or a minimum of 20mm from the penetration, which ever is the greatest dimension.

2 Insert the service pipe through the hole and apply a continuous bead of fire rated sealant

around the penetration directly on the exposed concrete face, refer to manufacturer's instructions to maintain fire rating.

3 Slide the fire collar over the service pipe and fix to the rediwall® wall as per the manufacturer's or Project Engineer's details.

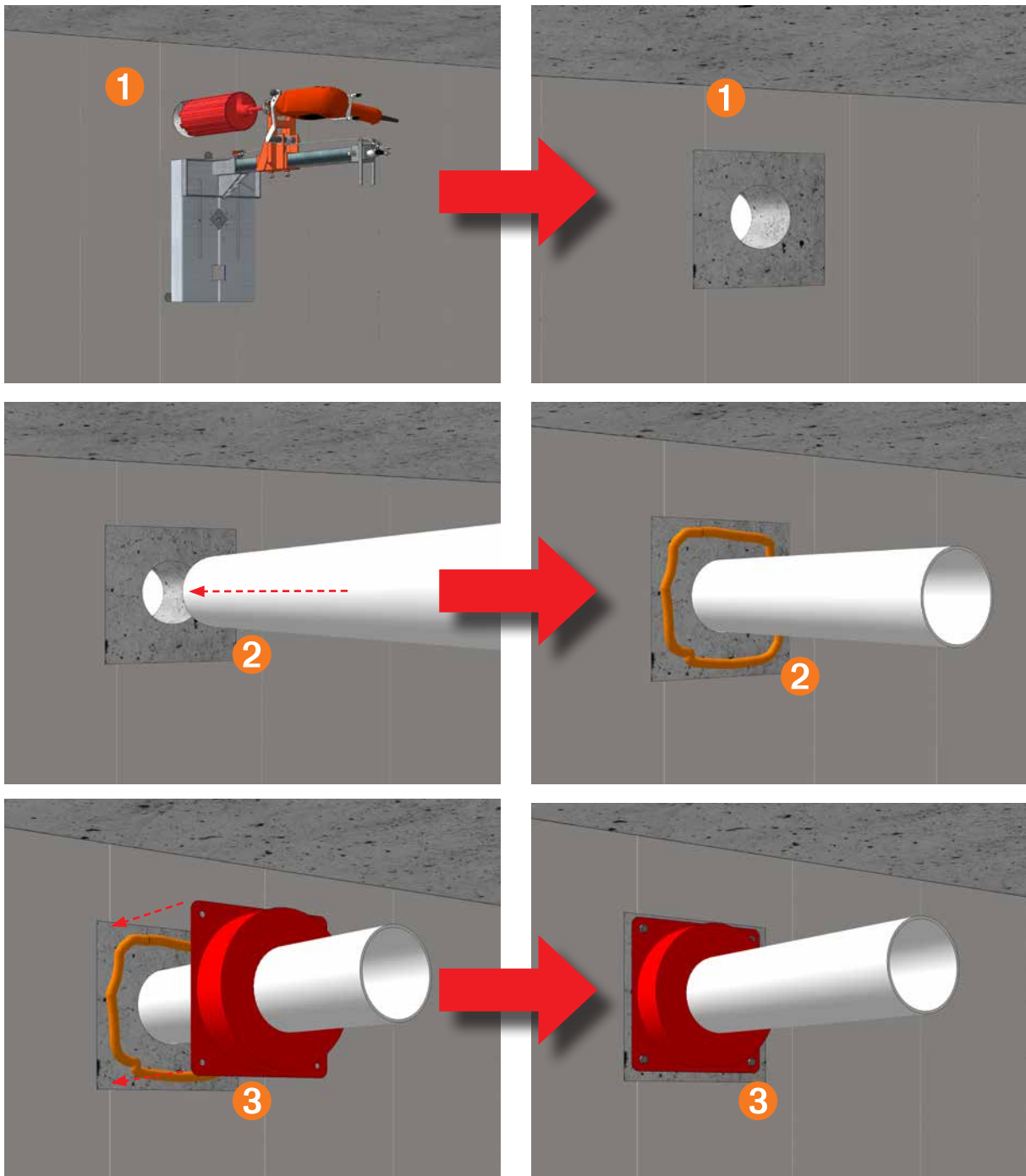

REDIWALL® TEMPORARY CONSTRUCTION BRACING

Introduction

Rediwall® requires temporary bracing for lateral stability during installation and core filling. The temporary bracing must withstand wind, seismic and other construction loads that may occur during erection of the components, during placement of the concrete and until installation of the permanent floor and/or roof members that provide a lateral load resisting diaphragm.

The bracing requirements for rediwall® are to be determined based on the wall thickness, the wall height, the wall layout, the presence of permanent or temporary framing (girts, columns, roof, etc.), and the wall erection method, which is either by installing off a formwork deck or from scaffolding, or off slab or footing.

Also, the wall bracing scheme and technique depend on the specific site climatic conditions, soil and foundation conditions, material availability, location wind loads, BCA and site specific requirements.

It is highly recommended that the Project Engineer or Contractor be contacted to perform the bracing calculations and drawings based on the specific site conditions and wall layouts.

AFS has certified standard bracing available for use, please refer to Volume 1 – "Design Performance & Compliance Guide" temporary works section for more details of the AFS standard bracing system and certification. Alternative details can be prepared by an Engineer or Contractor.

The wind loadings are to be calculated in accordance with relevant applicable Building Codes, and with the appropriate reduction factor for temporary bracing.

The rediwall® components provide permanent formwork for both faces of a wall and include integral internal webs to hold the two faces together during concrete placement.

Rediwall® requires a horizontal whaler between braces to ensure straightness of rediwall® elements.

Bracing is also required for areas that are subject to unbalanced hydrostatic pressure during concrete placement. Typically, these areas include openings, corners, T-junctions and wall ends.

The bracing should be re-checked immediately prior to the placement of concrete to ensure that all members are properly installed and that the rediwall® components are correctly located, aligned plumbed and braced.

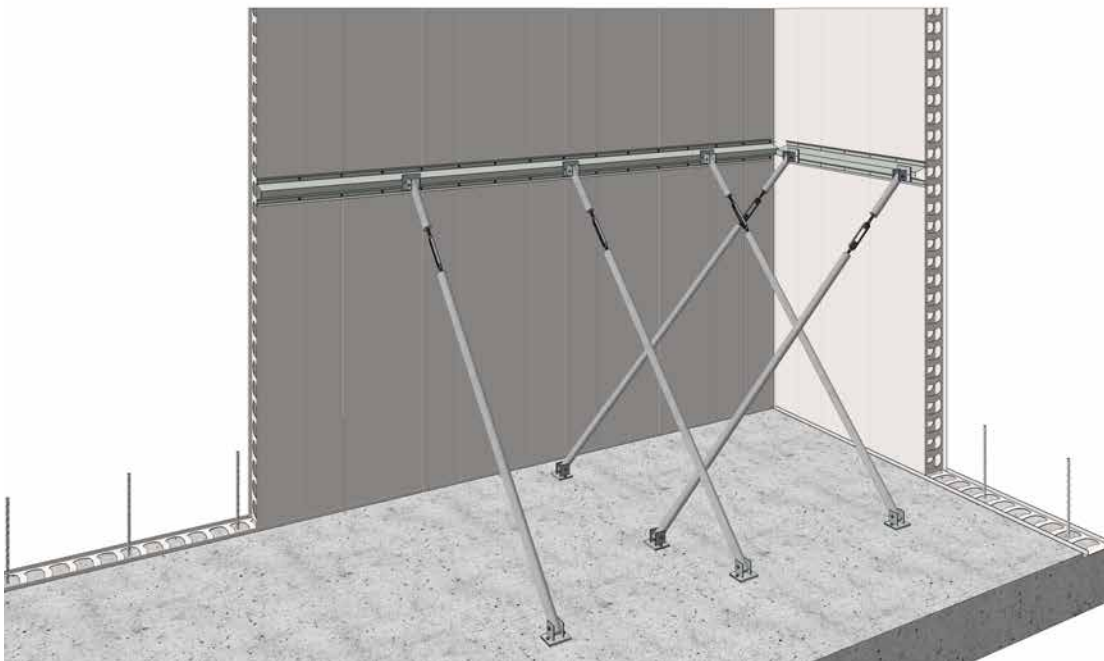

Bracing of Walls

Bracing of Walls to 3.3m Height

All rediwall® walls require horizontal bracing for lateral support prior to concrete pouring. This can be by attachment to a completed formwork deck or bracing struts secured to the panels and anchored to the slab.

For walls up to 3.3m height a continuous horizontal bracing member is required on one or both sides. The AFS standard bracing system has been designed and certified to cater for this configuration.

Site conditions such as high wind areas and work safety should be considered when bracing. Consult the Project Engineer for specific bracing requirements.

1 AFS recommends that the horizontal brace Top Hat be attached in the top one third of the panel height or at the top of the panels. As a minimum, the bracing Top Hats should be screw fixed to each rediwall® panel with two screws at the panel joint location.

2 The horizontal brace plate is to be connected to angled adjustable braces that are anchored to the slab or deadmen 1100mm apart. For walls over 3.3m contact the project manager or site engineer for details on bracing requirements.

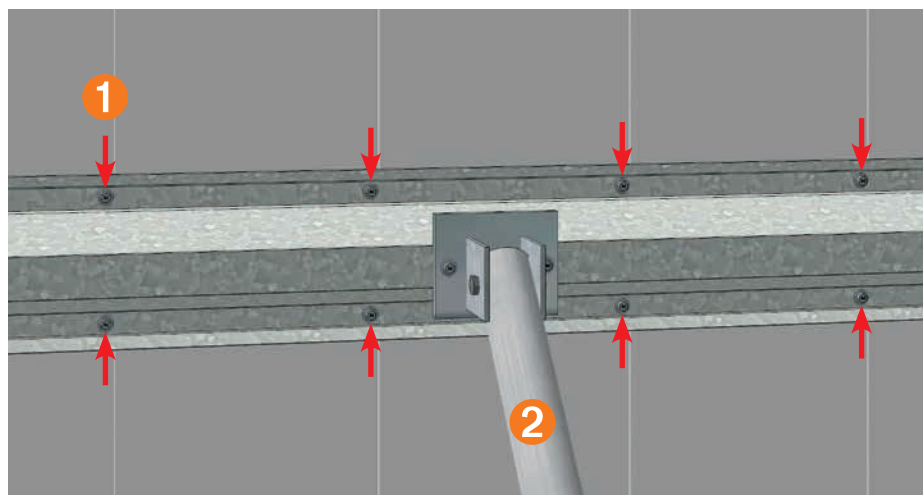
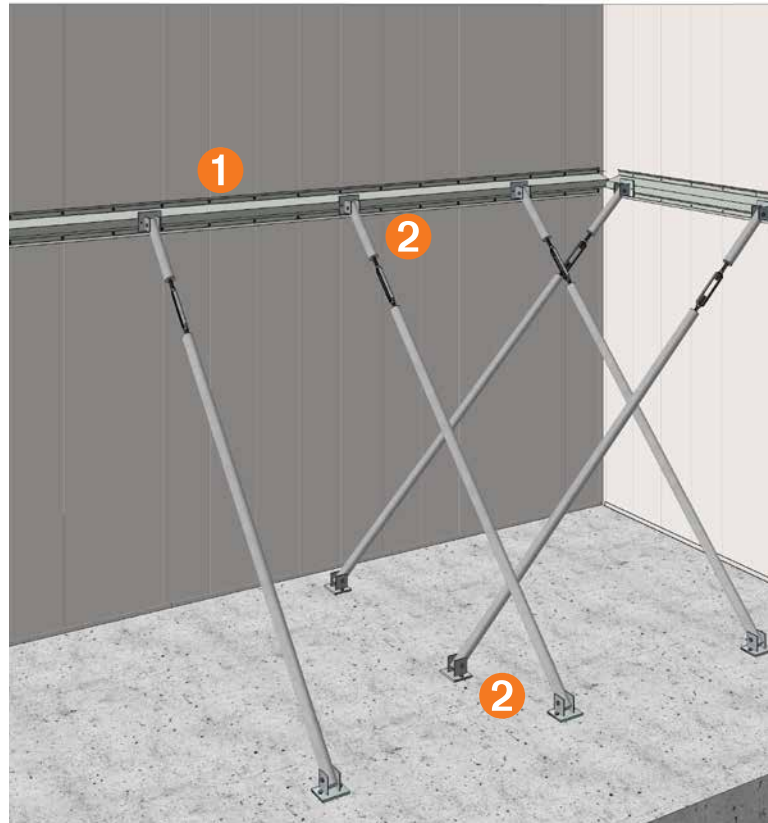

Bracing from Formwork Deck

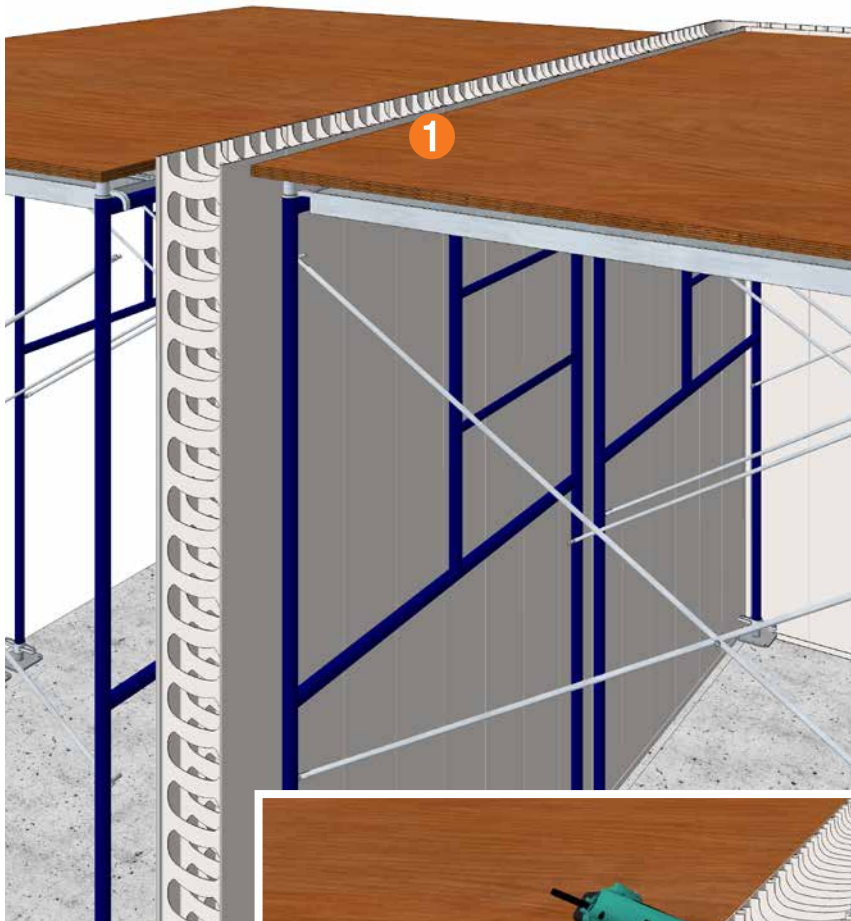

Rediwall® systems 3.3m or less in height that are being installed in conjunction with a formwork deck can be braced by being fixed directly into the form ply deck.

1 Formwork decking should be constructed and independently braced before erection of the rediwall® panels. Ensure deck is secure and at the appropriate height.

2 Fix rediwall® panels to the formwork deck using appropriate fixings at each panel.

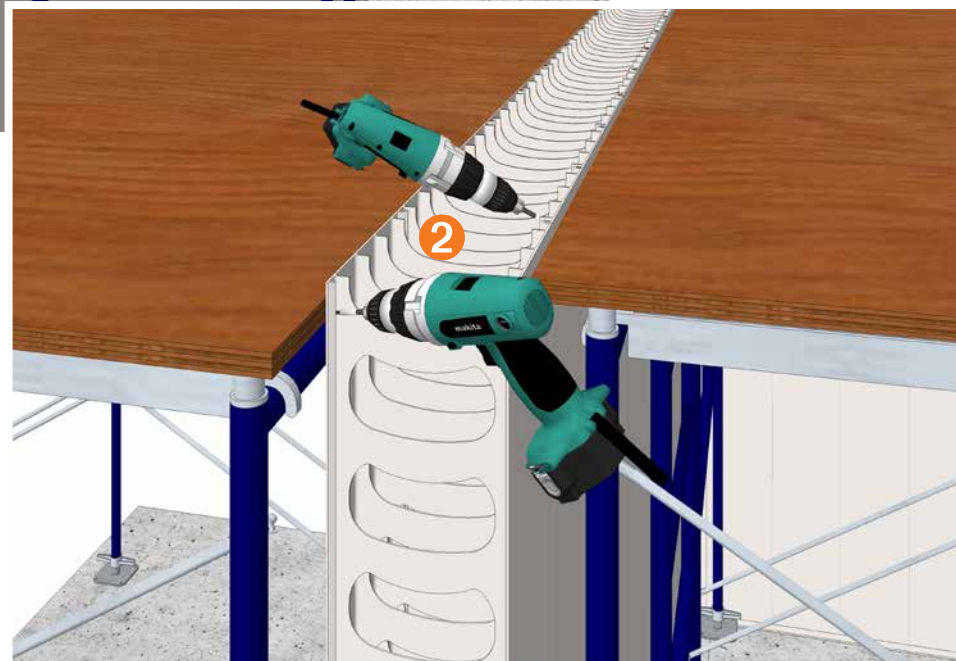

Bracing End Caps

The ends of walls, wall corners and wall intersections will tend to move laterally as the concrete is cast. AFS recommends full height bracing to prevent bulging during concrete placement.

- 1** The vertical bracing timber shall be the full height of the wall, and is to be pressed firmly against the wall end cap.
- 2** The vertical bracing is to be anchored to the wall panels using hoop iron straps. The straps shall be located at a distance of 300mm maximum from the top and bottom of wall. The spacing between the straps shall not exceed 1500mm. Screw fix hoop iron straps to at least 3 panels at the joint location on both sides of the wall.

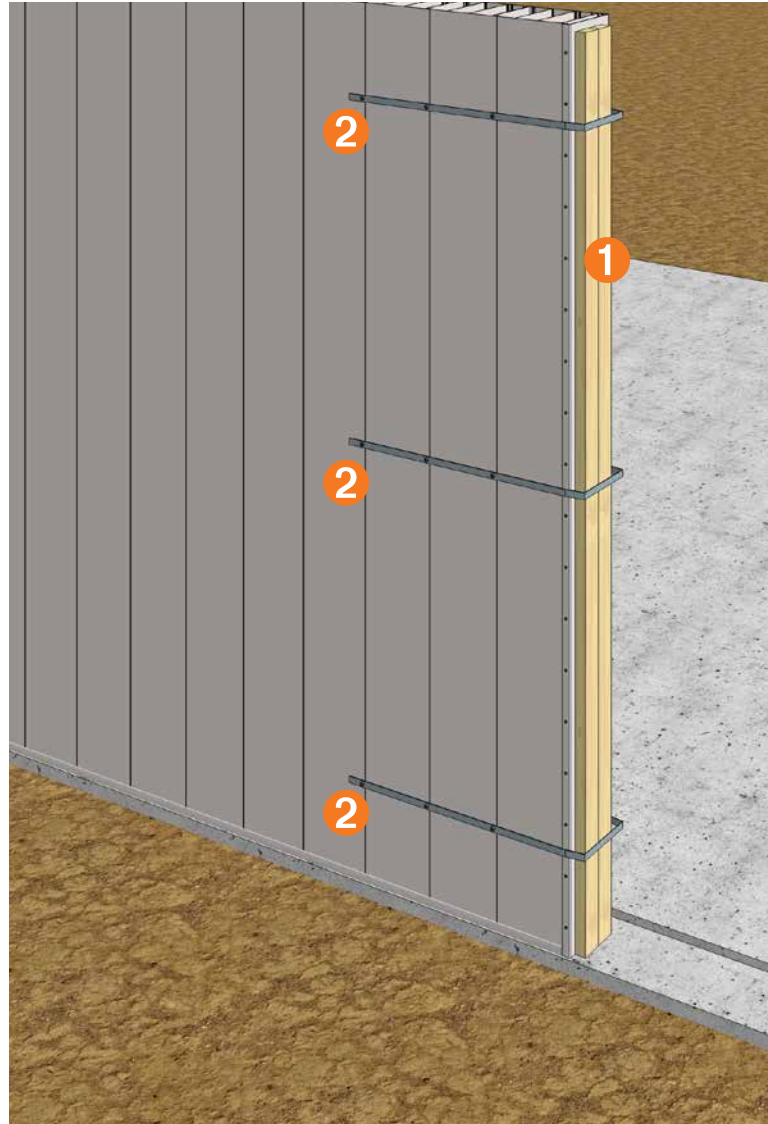

Bracing of T-Junctions

Where a T-junction is made, the main wall shall be adequately propped on the opposite side and local to the T-junction. This bracing is required to contain any lateral forces when this section of the wall is filled with concrete and to avoid dislodgement. For a short T-wall or nib, the end of this short T-wall shall also be adequately propped to stop potential bulging of T-junctions.

- 1 The external vertical bracing timber shall be the full height of the wall, and is to be pressed firmly against the wall opposite the T-junction. A backing plate of 19mm ply should be used with a width of a least 100mm overlap on either side of the panel junction width. For example RW200C requires an overall width of $100+200+100=400\text{mm}$

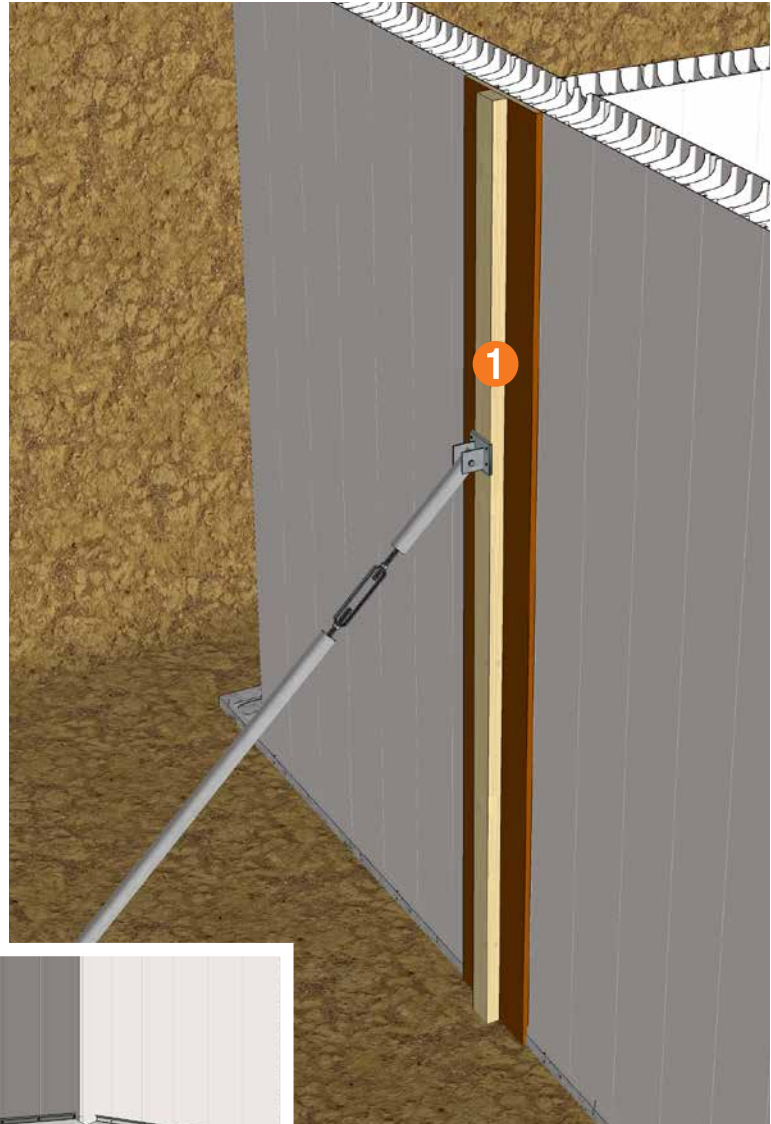

- 2 The internal bracing of the T-junction is to be in accordance with the standard bracing detail in this manual. All wall junctions must be braced.

Bracing of Rediwall® Edge Form

- 1 Contact AFS for information on edge form bracing. Alternatively contact the consulting project engineer, contract formworker or principal building contractor for details.

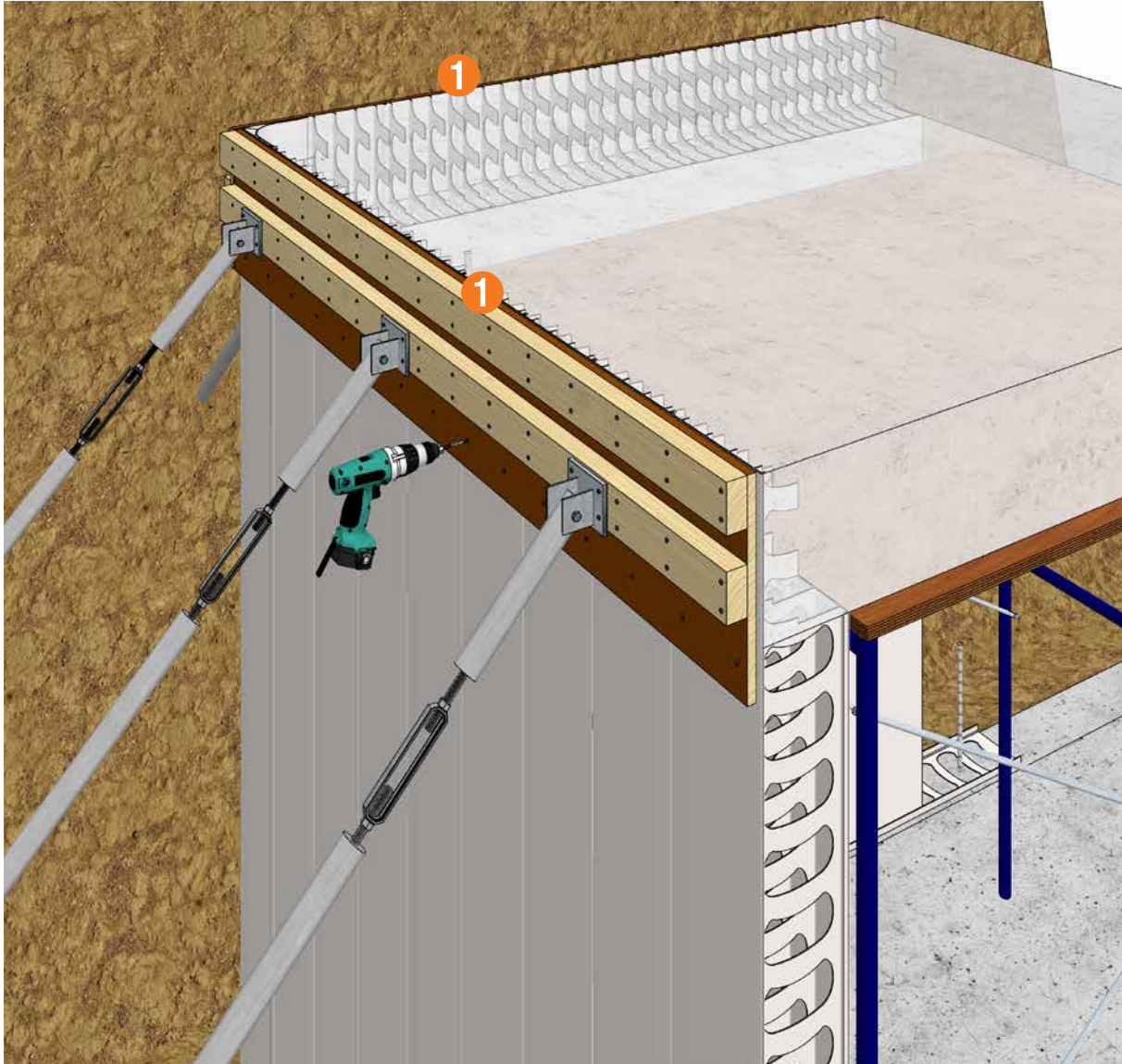

Bracing of Window Openings

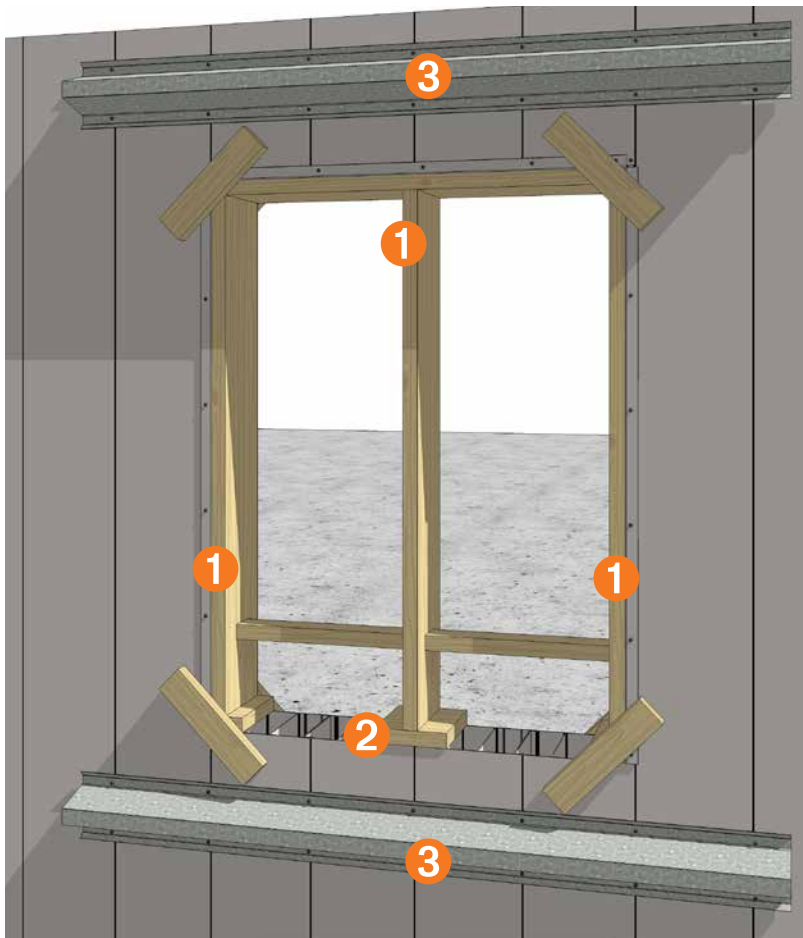

Refer to construction details for sill and lintel panel installation.

Openings can be distorted during the core filling process. AFS recommends that all openings be fully braced prior to core filling.

1 Continuous timber caps are required at the top and sides of all openings to maintain a flat surface and to prevent the face of the opening from bowing due to the vertical and horizontal concrete pressure. Caps are typically formed using conventional timber framing. The cap may be connected to the rediwall® components to prevent separation of the wall panel from the cap.

2 All timber caps require vertical and horizontal struts to support the head and jambs respectively, to keep the opening square, to resist the concrete pressure and weight and to maintain the correct opening dimensions.

3 The head and sill of openings more than 1.2m wide require a whaling plate on both faces of the wall to maintain a flat plane across the opening.

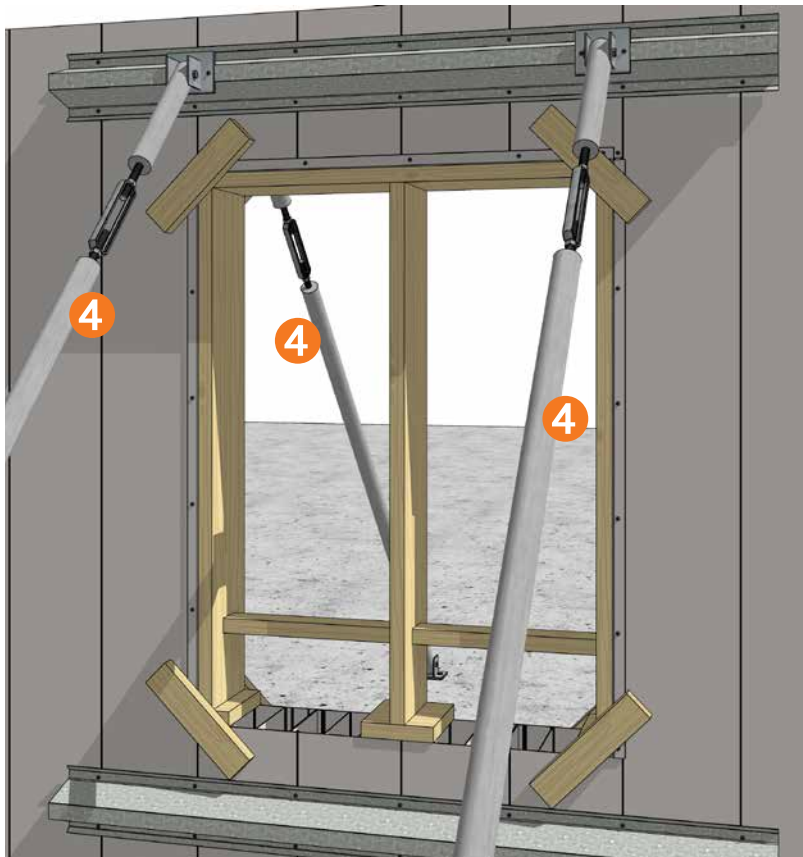

4 The whaling plate is connected to angled braces (at 1100mm maximum horizontal spacings) anchored to deadmen or the floor slab, in order to hold the opening plumb.

Bracing of Doorway Openings

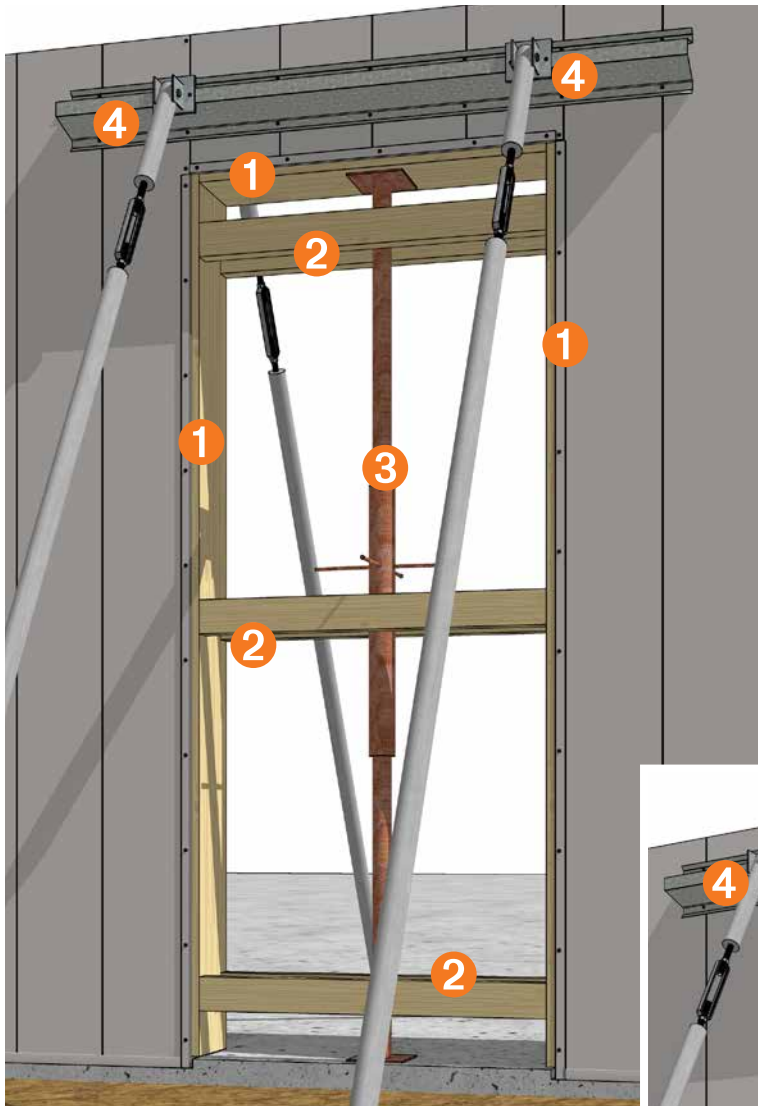

Refer to construction details for sill and lintel panel installation.

Openings can be distorted during the core filling process. AFS recommends that all opening to be fully braced prior to core filling.

Bracing – Formed Doorways

- 1 Brace sides and head of the opening to the full width of the wall with timber caps.
- 2 Install two parallel horizontal braces to the outer edges of the caps at the top, bottom and middle of the opening.
- 3 Install vertical shoring as required, (adjustable props may be used).
- 4 A whaling plate on both faces of the wall is connected to angled braces (at 1100mm maximum horizontal spacings) anchored to deadmen or the floor slab in order to hold the opening plumb.

Bracing – Metal Framed Doorways

Built in metal door frames must be installed accurately and squared/plumbed correctly. Refer to construction details earlier in this manual.

They also require sufficient bracing to prevent distortion during concrete filling, which can be achieved by installing metal turnbuckle braces or timber bracing.

- 1 Brace sides of the opening to the full width of the wall with timber caps.
- 2 Install two parallel horizontal struts to the outer edges of the caps at the top, bottom and middle of the opening.
- 3 The bottom of the metal door must also be braced to prevent the door from skewing. Run a timber chocks along each side of the foot of the door frame and fix to the concrete slab.
- 4 A whaling plate on both faces of the wall is connected to angled braces (at 1100mm maximum horizontal spacings) anchored to deadmen or the floor slab in order to hold the opening plumb.

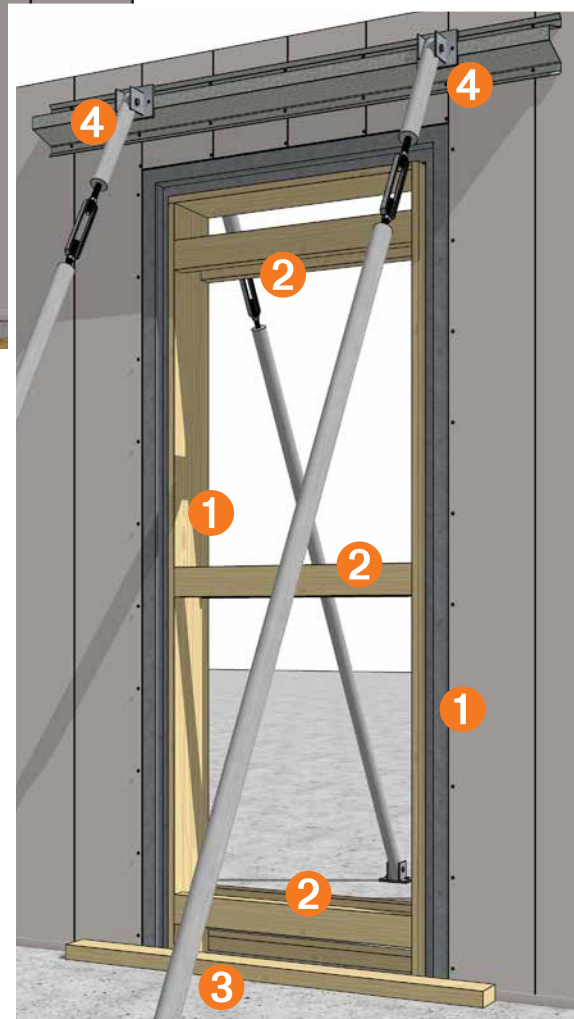

Bracing of Wide Radius Curved Walls

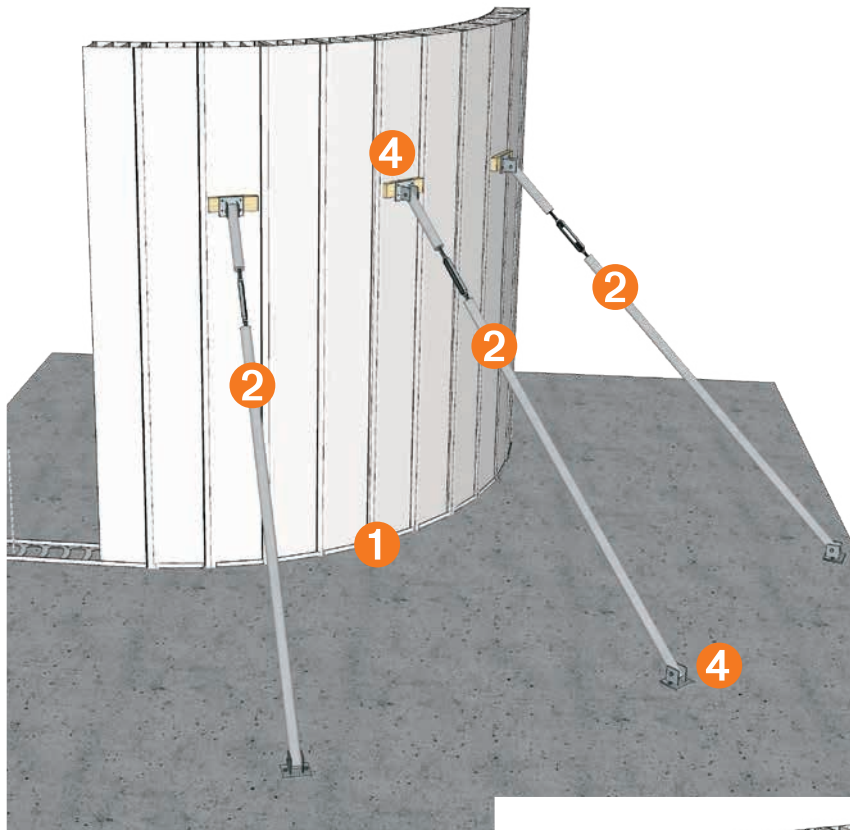

1 Ensure that all panels have been screw fixed to the floor track, and that all H-Joiners have been screw fixed to their adjacent panels.

2 Bracing must be used on the outer radius of a curved wall. It is recommended that at a minimum, every third wall section be braced.

3 For the internal radius of a curved wall use the same bracing technique as for a standard wall. It is recommended that at a minimum, every third wall panel be braced.

4 Screw fix the brace to the horizontal support and then securely fix the brace to the slab or deadman.

Bracing of Tight Radius Curved Walls (not shown here)

Ensure that all panels are screw fixed to the floor track and that all H-Joiners have been screw fixed to their adjacent panels.

Bracing must be used on the outer radius of a curved wall. Each infill spacer must be braced for the full height using suitable formwork timbers erected vertically against the infill spacer and braced diagonally back to the slab or deadman.

For the internal radius of a curved wall use the same bracing technique as for a standard wall. It is recommended that at a minimum, every third wall panel be braced.

Screw fix the brace to the horizontal timber support and then securely fix the brace to the slab or deadman.

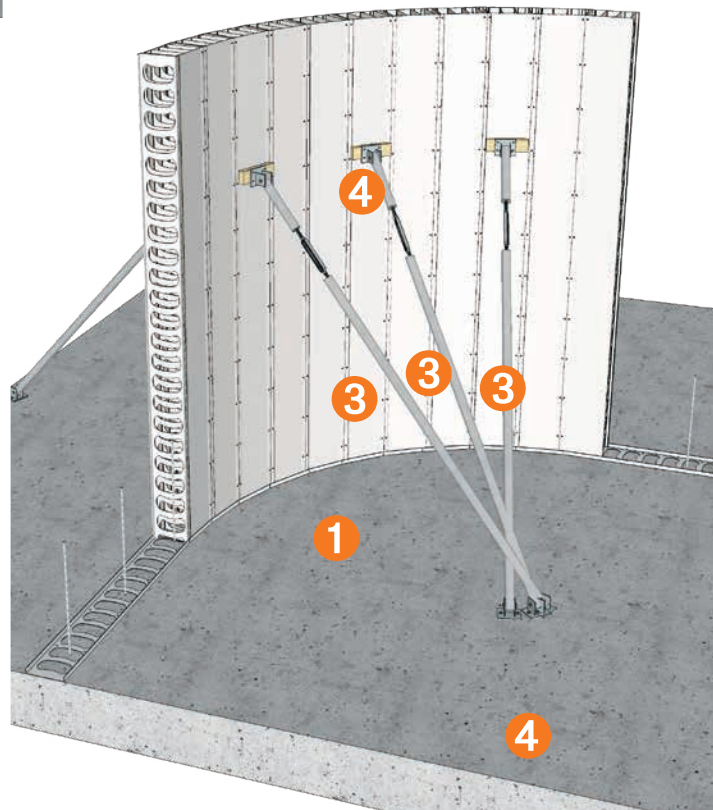

CORE FILLING OF WALLS

Introduction

AFS Rediwall® cannot be filled with concrete using traditional concrete mixes. The concrete mix and concrete placement technique is critical to the successful outcome of filling rediwall®.

AFS has carried out tests which achieved desired compaction and dense, homogeneous coverage of afs rediwall®.

This guide sets out the methods used by AFS to achieve suitable compaction.

Use of this guide or an equivalent procedure to achieve compaction of rediwall® is entirely at the discretion of the contractor or installer.

The contractor or installer is responsible for achieving compaction and dense, homogeneous coverage of the concrete mix in rediwall®. AFS accepts no responsibility for achieving compaction of the concrete in afs rediwall® or core filling of walls.

Concrete Pour Limitations

When panel installation is complete and all appropriate bracing and checks completed, the walls can be filled with concrete.

The quantity of concrete that can be poured in a day must be assessed and determined in consideration of the following factors:

- Ease of access
- Number of passes (or lifts) that are required
- Concrete gelling time between passes
- Consideration of wet weather

For wet weather, on-site conditions should be assessed and the concrete pour either be delayed or be undertaken with caution, applying measures to suit the given conditions.

Additional Equipment Required for Concrete Pour

Prior to commencing a pour, ensure that a concrete vibrator with flexible shaft and 38mm head is ready for use, and that multiple shovels, trowels, screw guns, screws and at least one wheelbarrow are readily available.

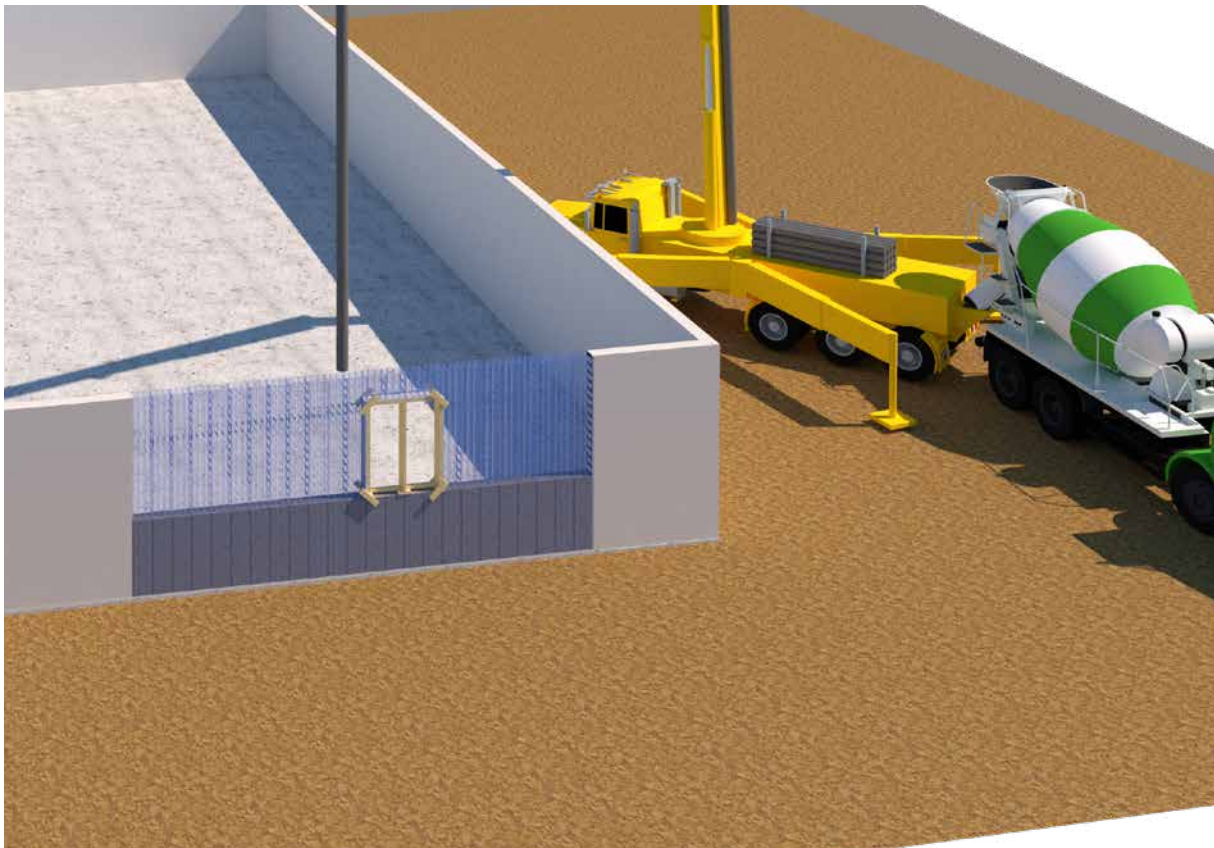

Number of Concrete Passes/Lifts Required

Walls up to 3 metres high can be filled in 2 passes/lifts with the first pass being to a maximum height of 1.2 – 1.5m. Walls from 3 – 6m should be filled in 3 – 4 passes with the first and second pass being to a maximum height of 1m each.

Allow at least 45minutes between passes for concrete to gel.

Higher concrete strength mixes will gel faster than low strength mix designs. These guidelines will vary according to site conditions, with the requirement of extra passes and extra gelling time in wet/cold weather. In cases of extreme weather the concrete pour should be postponed.

Concrete Usage

Rediwall® Panel	RW110C	RW156C	RW200C	RW256S
Per Cubic Metre of Concrete	Square Metres of Wall Area			
	9.61m ²	6.67m ²	5.1m ²	4.0m ²
Per Square Metre of Wall Area	Cubic Metres of Concrete			
	0.104m ³	0.15m ³	0.194m ³	0.25m ³

Concrete Mix Design Guide

	Standard AFS Pump Mixes				High Workability Mixes		
	Refer to Structural Engineer for Mix specification						
Strength $f'c$ (MPa)	S25	S32	S40	S50	S40	S50	S65
Target Installation Slump	140±10	140±10	140±10	140±10	170±20	170±20	170±20
Design Slump (mm)	140	140	140	140	170	170	170
Maximum W/C Ratio	0.7	0.6	0.45	0.4	0.45	0.4	0.35
Nominal Fine to Total Aggregate Percentage (%)	65	60	55	50	55	50	50
Maximum Aggregate Size (mm)	10	10	10	10	10	10	10
Maximum 56 Day Drying Shrinkage (µm)	1000	1000	1000	1000	1000	1000	1000
Hanson Recommended Admixtures	WRPAPN20 (WR) ex Grace, ADVA-142 (HWR) ex Grace						

Notes:

- Site water is allowed to be used to reach desired installation slump however, the maximum W/C ratio must not be exceeded.
- Due to local raw material availability, characteristics will vary significantly, refer to Project Engineer for further details.
- The addition of all admixtures are typically dosed at the beginning of the batch.
- Concrete mix should have a typical 'Gel' time of 30-60min in accordance with the Gel Test detailed in this guide.

Concrete Mix Design

The concrete supplier is responsible for providing a mix design that is suitable for filling rediwall®.

The concrete core fill mix must be designed with enhanced flow characteristics. Such concrete is available from Hanson Concrete, Holcim and most other concrete suppliers.

AFS trials and experience have shown that a concrete mix that is designed such that segregation and blowouts are prevented whilst achieving the required level of compaction will have the following basic characteristics:

- $f'c$ = 25 to 65 MPa (to be as specified by the project structural engineer).
- Water to cement ratio of 0.55 maximum. (This may provide more cement than required for strength but the high cement content is required to enhance flow).
- 8-10mm maximum aggregate.
- Batched at 80mm slump before admixtures.
- A long line, or pumpable wall mix is normally used to fill rediwall®. Block fill mix is not recommended.

Concrete Delivery & Placement

The concrete must be placed using a suitable concrete pump via a 50mm delivery hose. Never fill rediwall® using a kibble.

The average pump rate for core filling afs rediwall® is 12m³ per hour. It is important to advise the concrete supply company of the required delivery turnaround time. (e.g. 1 x 5m³ load every half hour, taking approximately 30mins to empty the truck).

Admixtures including plasticiser and flyash are used to increase the target slump to 170mm maximum for standard AFS pump mixes.

Concrete 'Gel' Test

The concrete core filling of rediwall® is undertaken in passes, with concrete pours limited to 1500mm high per pass. A simple reinforcement test shall be undertaken to check that concrete in each pass has 'gelled' sufficiently before the subsequent pass (typically 45 minutes or more). The test steps are as follows:

- A. After the first pass of the concrete pour, lower an N12 or N16 reinforcement bar into the rediwall® cavity until the reinforcement contacts the wet concrete.
- B. Let the reinforcement bar fall under its own weight. If the reinforcement bar sinks 75 - 125mm into concrete and stops, it indicates that the concrete has 'gelled' sufficiently for the second pass of the concrete pour to commence.
- C. If the reinforcement bar does not stop and continues to go down into the wet concrete, the concrete is still too wet for commencement of the second pass of the concrete pour. Allow suitable time for the concrete to 'gel'. Then, conduct the test again to check and ensure that it meets the bar sink criteria as noted in Step 'B' before proceeding to the next pass of the concrete pour.
- D. Depending on wall height, the gel test shall be carried out for all subsequent passes of the concrete pour.

Note: Over vibrating can result in bulges and/or blowouts. Avoid touching the panel faces with the vibrator. Keep vibration to a minimum.

Concrete Pour Procedure

CORNERS

Start pouring the wall in the 'Corner'. Hold the hose directly over the panels, moving back and forth over the webs and onto the horizontal reinforcement bars to slow down the concrete flow rate, till the maximum pour height of 1500mm is reached.

If pouring from one corner to the next (Lift Shaft, etc), move the hose forward to the corner and work your way back to the middle of the wall, till the maximum pour height of 1500mm is reached.

Note: When using the afs rediwall® corner assembly the outer corner edge voids do not need to be concrete filled to maintain structural integrity of the corner section.

T SECTION

Start pouring the wall from the 'T-Section'. Hold the hose directly over the panels, moving back and forth over the webs and onto the horizontal reinforcement bars to slow down the concrete flow rate, till the maximum pour height of 1500mm is reached.

If pouring from one 'T-Section' to the next, move the hose forward to the 'T-Section' and work your way back to the middle of the wall, till the maximum pour height of 1500mm is reached

END CAPS.

Start pouring the wall from the 'End Cap'. Hold the hose directly over the panels, moving back and forth over the webs and onto the horizontal reinforcement bars to slow down the concrete flow rate, till the maximum pour height of 1500mm is reached.

If pouring from one end cap to the next, move the hose forward to the endcap and work your way back to the middle of the wall, till the maximum pour height of 1500mm is reached.

COLUMNS AND BLADES

Start pouring the wall from the 'End Cap'. Hold the hose directly over the panels, moving back and forth over the webs and onto the horizontal reinforcement bars to slow down the concrete flow rate, till the maximum pour height of 1500mm is reached.

If pouring from one 'End Cap' to the next, move the hose forward to the 'End Cap' and work your way back to the middle of the wall, till the maximum pour height of 1500mm is reached

DOOR FRAMES

Start pouring the wall from the 'Door Frame'. Hold the hose directly over the panels, moving back and forth over the webs and onto the horizontal reinforcement bars to slow down the concrete flow rate, till the maximum pour height of 1500mm is reached.

If pouring from one door frame to the next, move the hose forward to the door frame and work your way back to the middle of the wall, till the maximum pour height of 1500mm is reached.

Start locations and pour lines

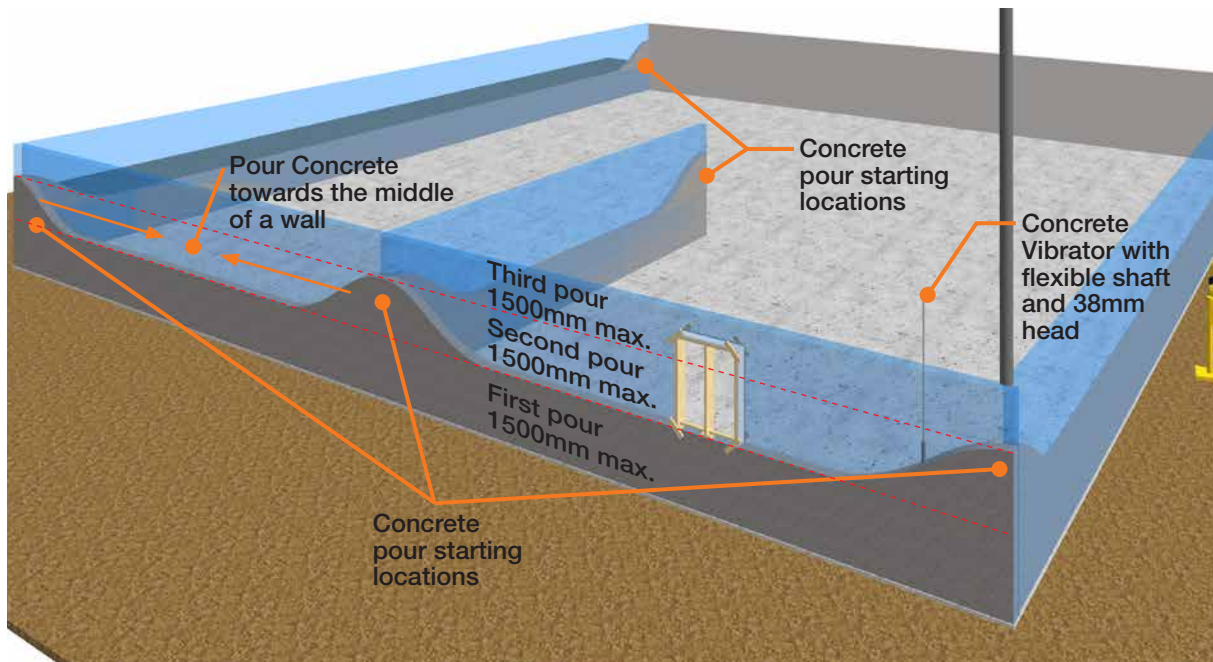

WINDOWS AND HEADERS

At openings, such as windows or large mechanical penetrations, lower the hose under the formwork deck and ensure all sills are adequately filled. On the remaining lifts, core fill headers and lintels.

Use of a concrete vibrator in AFS Rediwall®

For the vibration of concrete a concrete vibrator with flexible shaft and 38mm head is to be used. Place the vibrator at the bottom level of the pour and move up and out of the pour zone. Repeat every 300-400mm apart, in each completed pour (max 1500mm height).

Care should be taken when vibrating not to directly vibrate the reinforcing steel to ensure monolithic concrete wall.

The vibrator must not be or held against the panel faces as this may result in panel failure.

Finishing of Sills & Top of Wall

When the sills and tops of walls have been filled, they should be neatly trowel finished.

The top of the sill/wall is either:

1. Left set down slightly if a slab is to be poured over the top;
- OR
2. Trowelled off smooth to 5mm fall if it is the finished top of a wall or if it is to be the bearing edge for Delta-core or Ultra-floor to sit on.
- OR
3. If the top of wall is to be left exposed, an additional waterproof capping is to be added.
- OR
4. Trowelled off smooth to 5° fall if it is the finished top of a window sill.

Placing of 'L' Bars at top of wall

Reinforcing 'L' bars may be required to be placed in the wet concrete at the top of the wall to tie the wall and future overhead floor slab together.

Reinforcing 'L' bars must be placed and temporarily held in-place until the concrete cures. Design, spacing and placement are the responsibility of the Project Engineer.

Concrete Clean-up

During the pour, some concrete splatter may occur on the slab below and down the face of the afs rediwall® panels.

All concrete splatter must be cleaned off before it cures.

Team members should follow the pour, brushing all splattered concrete off the slab and walls and if necessary, wiping the walls down with a wet sponge.

Early Removal of Temporary Bracing

Temporary bracing is normally removed once the slab over is poured or the roof is attached. However, if due to site conditions or other circumstance, it is desirable to remove the temporary bracing earlier, approval must be obtained from the Project Engineer, especially in situations where the rediwall® is to become a retaining wall and will be back-filled against, or is to be loaded with a pre-cast slab system such as 'Delta-core.'

Cleaning of Finished AFS Rediwall®

For cleaning of finished rediwall®, use high pressure water blasting, conducted in a similar way to brick cleaning. If required, a 10% acid or lemon concentrate can be added to the cleaning mix.

Patching of holes after removal of temporary bracing can be achieved by applying colour matched filler sealant or equivalent. Once dry, remove excess with sharp chisel or blade to achieve a flat surface.

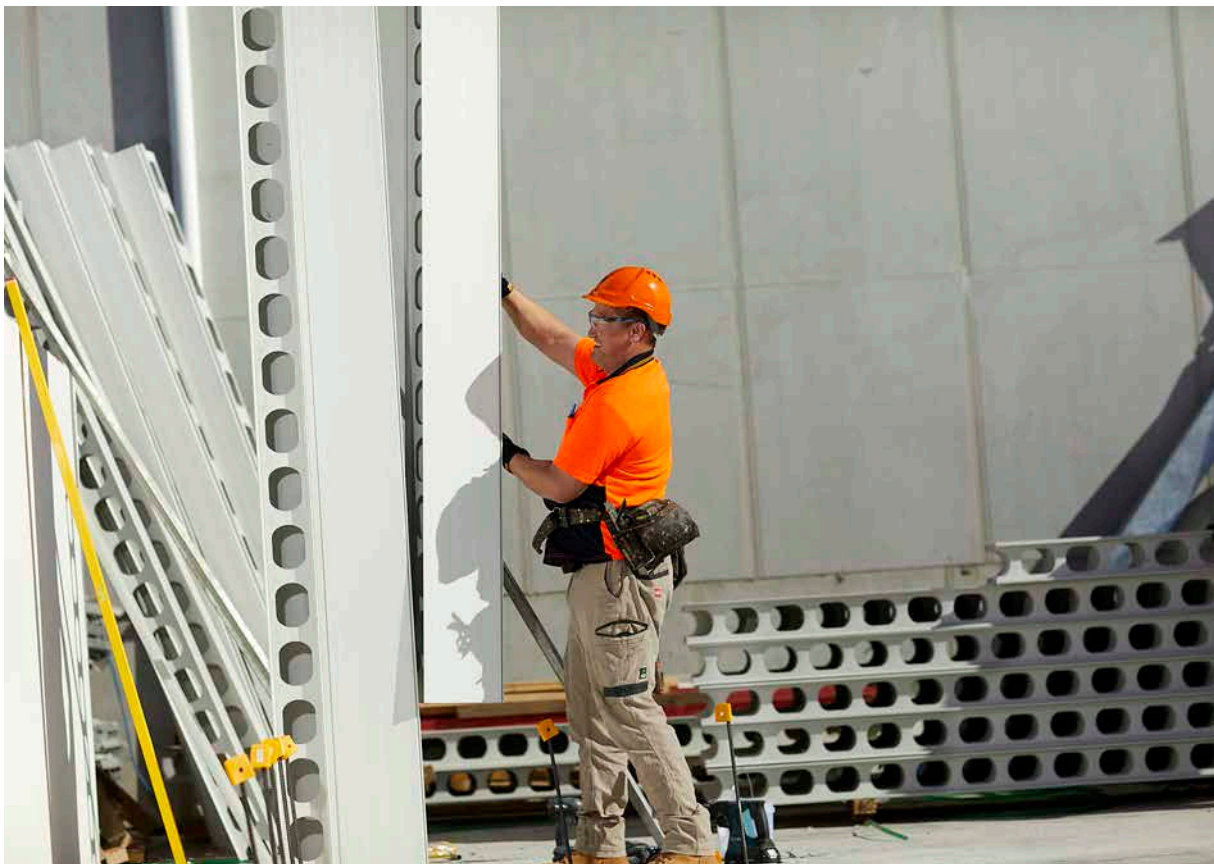

NOTES:

A large rectangular area filled with a grid of small, evenly spaced dotted lines, intended for handwritten notes.

NOTES:

A large rectangular area filled with a grid of small, evenly spaced dotted lines, intended for writing notes.



Disclaimer: Information presented in this document is supplied in good faith and to the best of our knowledge was accurate at the time of preparation. The provision of this information should not be construed as a recommendation to use any of our products in violation of any patent rights or in breach of any statute or regulation. Users are advised to make their own determination as to the suitability of this

information in relation to their particular purpose or specific circumstances. Since the information contained in this document may be applied under conditions beyond our control, no responsibility can be accepted by AFS or CSR, or its staff for any loss or damage caused by any person acting or refraining from action as a result of misuse of this information.

(C) 2019 AFS Systems Pty Ltd ABN 455 760 727 88
RED 00036 APR19
BMS1668.0419

afs

afsformwork.com.au • 1300 727 237

AFS Systems Pty Ltd • 110 Airids Road, Minto NSW 2566

CSR